



# Installation Instructions

## RB 500 Manual Roller Shades

### Heavy Duty Clutch Coupled

5-217 Series-Coupled Unit

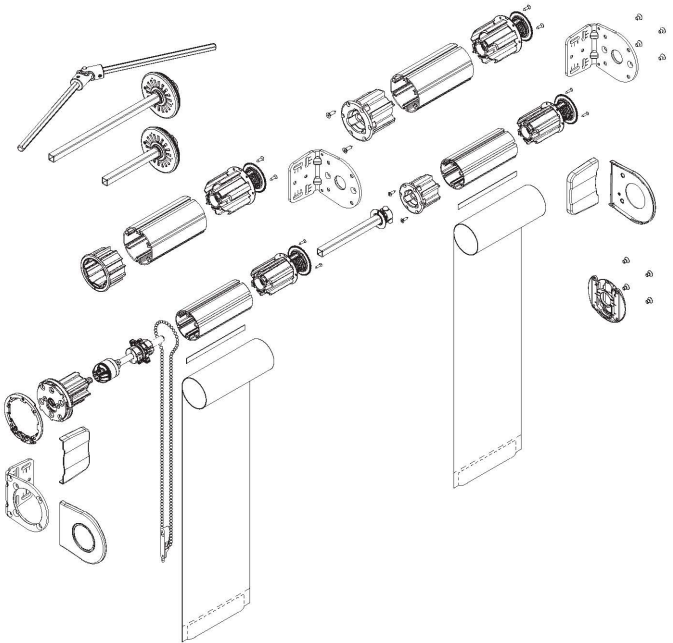

**HunterDouglas**   
Architectural

## Installation

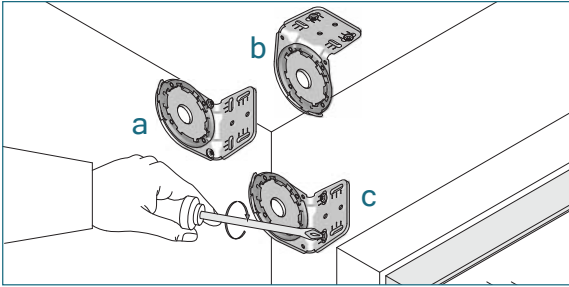

Install the clutch bracket & intermediate plug bracket first. a) recess b) ceiling c) wall

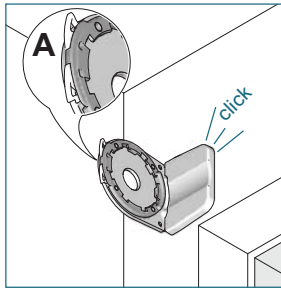
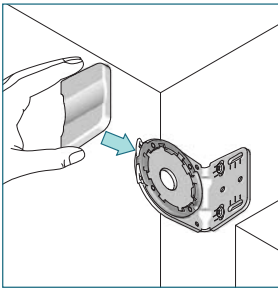

Slide the screw cover onto the bracket until it snaps. Open the fastener on the clutch bracket adapter (A).

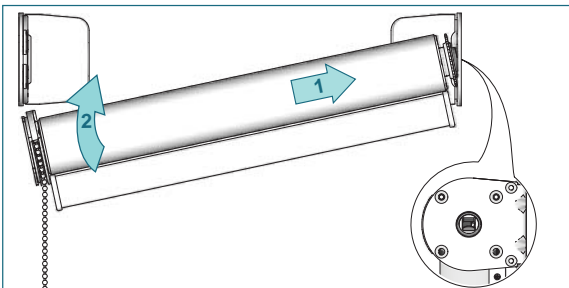

Place the roller shade with the idle end onto the intermediate bracket. Push the shade against the tube bearing plug and lift the shade into the clutch bracket.

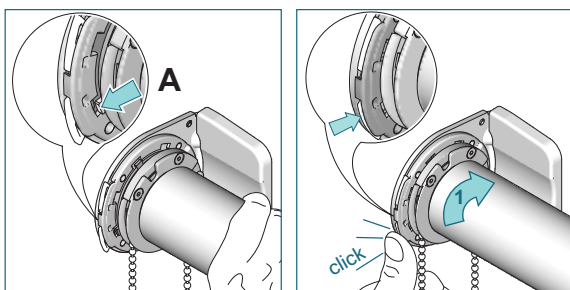

Line up teeth of the clutch with bracket adapter (A). Insert clutch, turn shade (10°) in the rolling off direction (1), and close fastener on the bracket adapter.

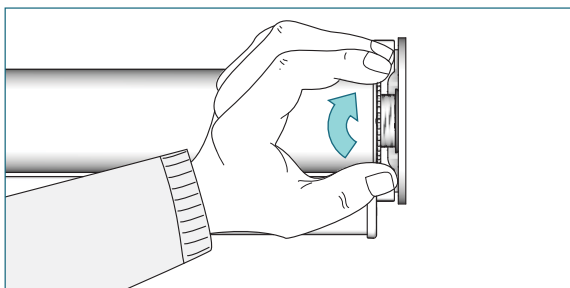

Secure the shade by turning the locking ring furthest away from the bracket.

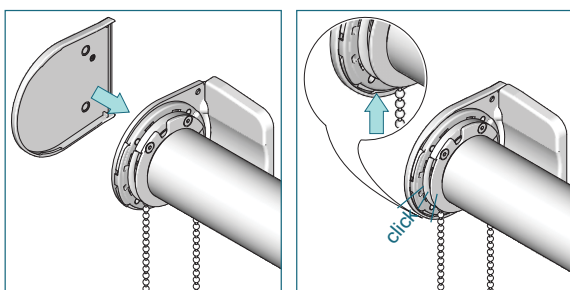

Attach the bracket covers onto the brackets. Make sure the bracket covers snap onto the brackets.

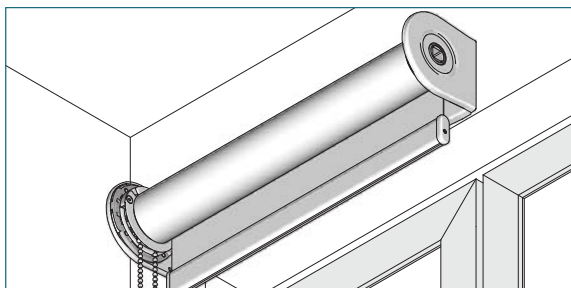

Make sure the bracket cover is on the intermediate plug bracket.

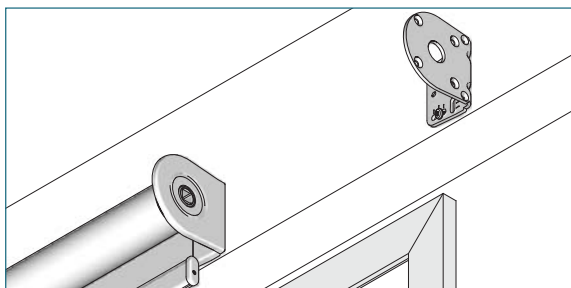

Install the end plug bracket with screws provided.

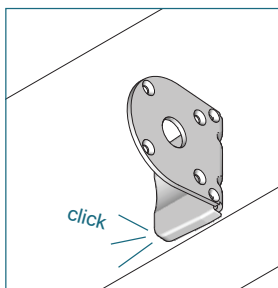
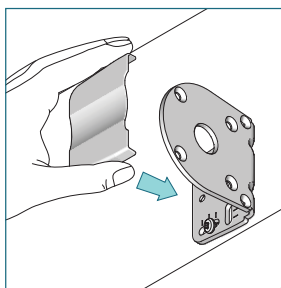

Slide the screw cover onto the bracket until it snaps.

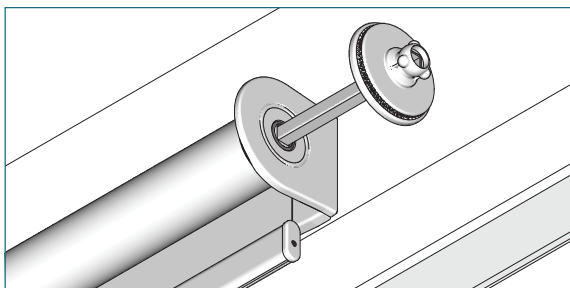

Slide the aligner or the connector set through the intermediate bracket into the tube bearing plug.

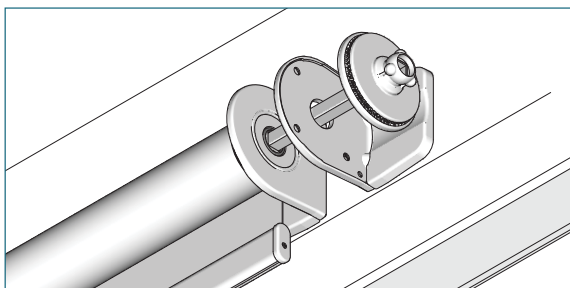

Shades with custom width gaps or Joint 45° will require 2 intermediate brackets. Slide the aligner or connector set through the intermediate bracket into the tube bearing plug.

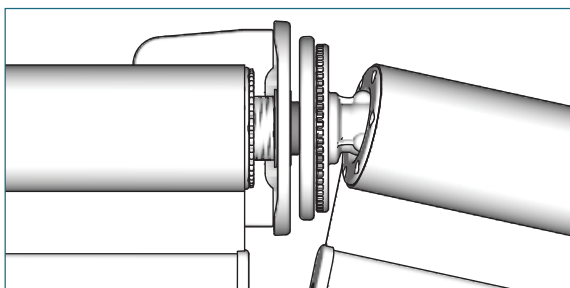

Place the tube with plug connector on the aligner or connector set head.

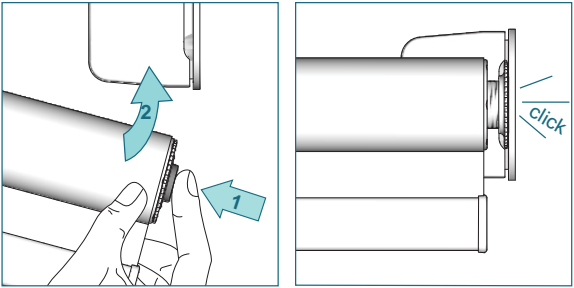

Press the tube bearing plug, lift the roller shade and snap it to the bracket.

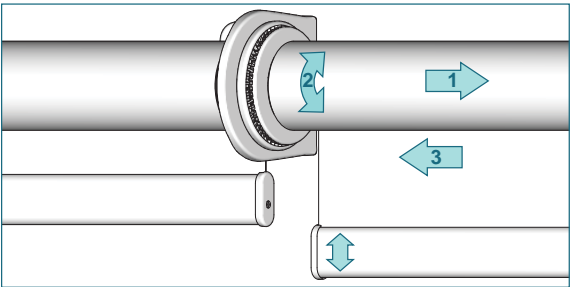

To align the bottom hembar, pull the shade away from aligner set (1), turn shade to line up bottom hembar together (2). Release shade to secure position (3). Not possible when using connector set.

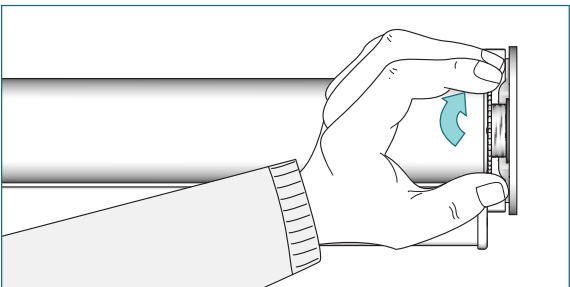

Secure shade band by turning the locking ring on tube bearing plug furthest away from the bracket.

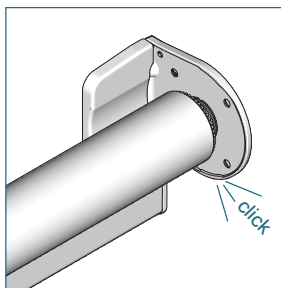
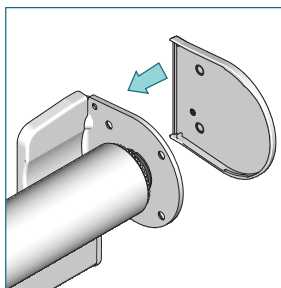

Slide the bracket cover onto the bracket. Make sure that the bracket cover snaps onto the bracket.

### Option: Leveler

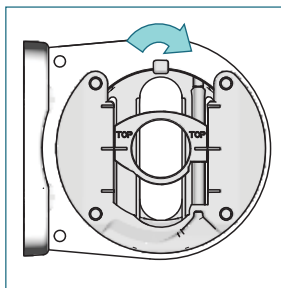
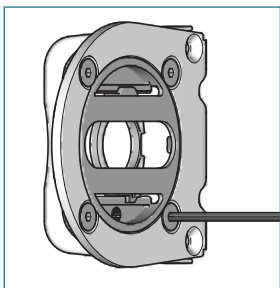

Make sure that the opening for the Allen key is pointing downwards before installing the brackets. Change the orientation by loosening the 4 screws and turning the leveler 90°. Reinstall the screws.

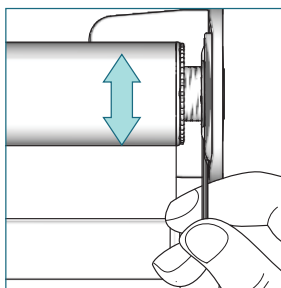
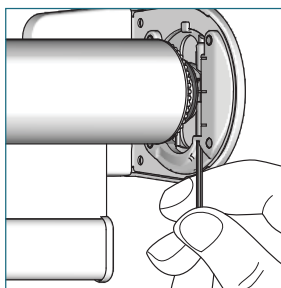

To adjust skewing, put the provided Allen key into the screw of the leveler and turn it left or right to move the roller shade up and down. Support lifting of large heavy roller shades with the palm of your hand.

## Removal

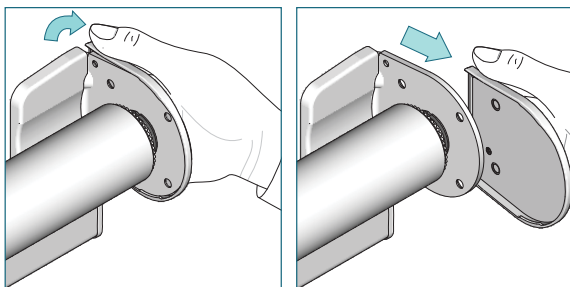

Lift the backside of the bracket cover and slide it towards you.

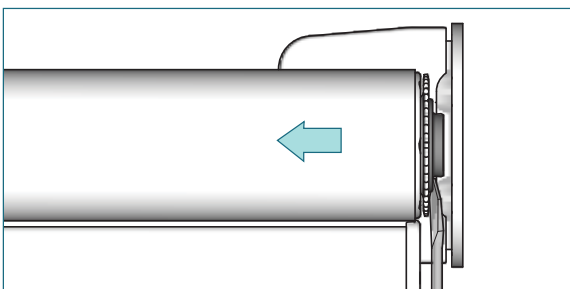

Unfasten the locking ring. Slide a screw driver between locking ring and bracket and push the tube bearing plug in the aligner/connector direction.

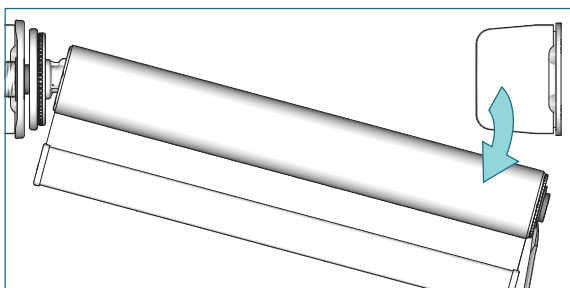

Move the roller shade downwards out of the bracket. Pull the aligner or connector out of the tube bearing plug.