

METAL CEILINGS

PLANK & TILE
GLADIUS™



The Gladius™ metal ceiling panel snaps into place on a 15/16" grid system using a patented "stab and click" design. The self-centering, self-leveling, and self-aligning installation is confirmed by an audible "click".

© Bob Perzel

Project: Luxury Auto Mall, Tucson, AZ; Gladius™

KEY FEATURES

- Panel size: 24" x 24"
- Square-edge design
- Waste reduction with factory fabricated dimensional material
- Downweight: reduce dead load with lightweight aluminum
- Easy plenum access
- Interior and exterior applications
- Compatible with industry standard lighting, HVAC, speaker, fire safety, and security services

COLORS & FINISHES

Standard colors Natural and Cotton White shown. Client-specific colors available. Minimum quantities may apply. Colors are for illustrative purposes. See page 178 for all colors and finishes.

Standard colors

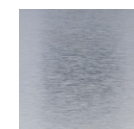

Natural



Cotton White

Custom colors



Custom

Woodwright™ finishes use our painted wood-look finish. See page 180 for all finishes.



Maple



Cherry

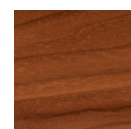

Walnut

TYPICAL ISOMETRICS

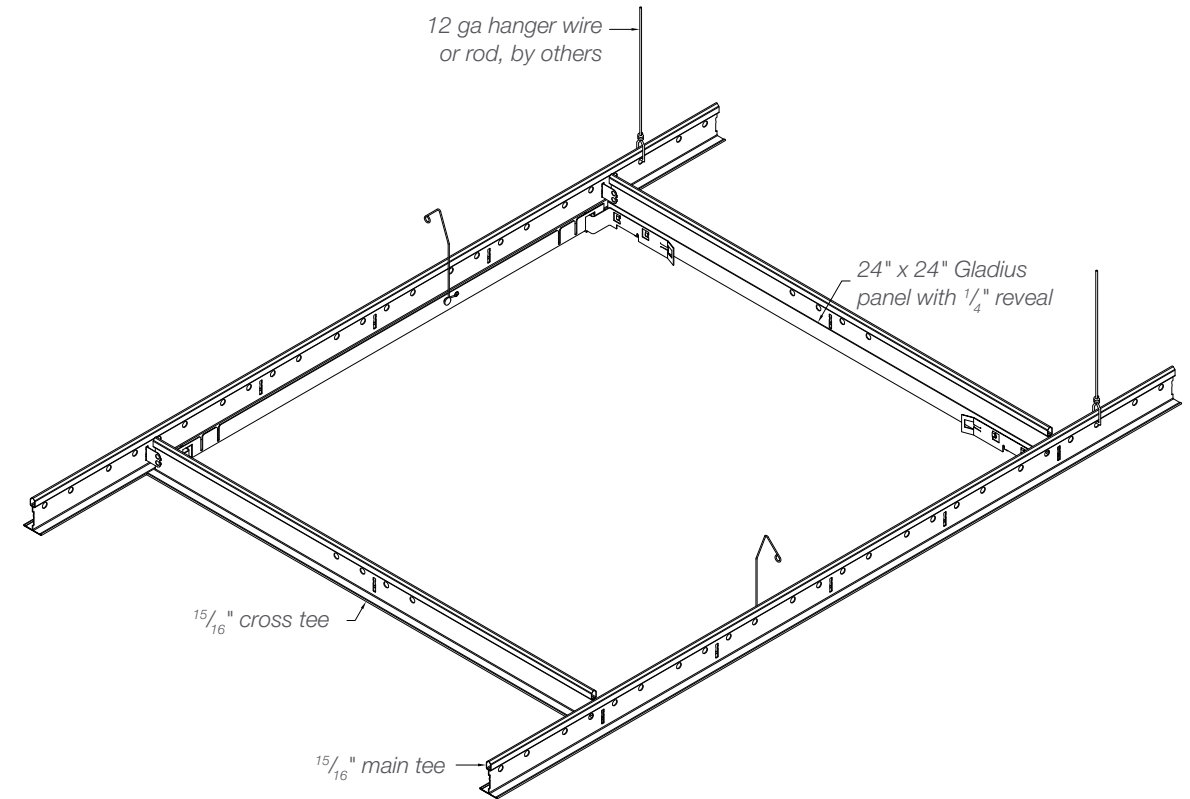

PERFORATION PATTERNS

Standard patterns shown. See page 186 to see all perforation patterns. Scale shown: 1:1, unless otherwise noted.



Non-perforated

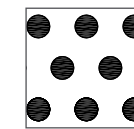

Pattern #103

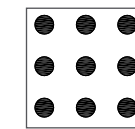

Pattern #106

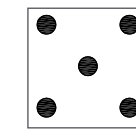

Pattern #119

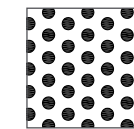

Pattern #127

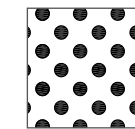

Pattern #132

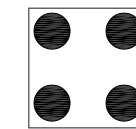

Pattern #201

Scale 1:2

PHYSICAL DATA

- Substrate:** Aluminum
- Warranty:** 1 year
- Seismic rating:** Zones A,B,C,D,E,F
- Fire rating:** Class A Fire Rated per ASTM E84
 - Painted or anodized metal: Flame spread: ≤ 25, Smoke ≤ 50
- Weight:** 1.0 lbs./sq.ft
- Wind load:** Per code (for exterior applications)
- Recycled content:** Up to 92%
- Light reflectance (LR) Coefficient per ASTM E1264 & ASTM E1477:**
 - Cotton White: LR = 0.81
- Acoustical ratings – NRC:** See page 190

BIM

REVIT files available for BIM contributions, see website for details.

LEED V4 CREDITS

- EA:** Optimize Energy Performance
- MR:** Building Product Disclosure
- EQ:** Low-Emitting Materials
- EQ:** Indoor Air Quality Assessment
- EQ:** Daylight
- EQ:** Acoustic Performance

CERTIFICATIONS

GREENGUARD Gold Certified
HPDs & EPDs – available upon request