

METAL CEILINGS

EXTERIOR – LINEAR PLANK  
300C



Designed to withstand wind loads, 300C metal ceiling panels offer a subtle, long span design for exterior ceilings.

© Bob Perzel

Project: Luxury Auto Mall, Tucson, AZ; 300C Exterior

KEY FEATURES

- Panel width: 12" nom. [300 mm]
- Panel lengths: 3' to 19'-8"
- Bevel-edge design
- Waste reduction with factory fabricated dimensional material
- Downweight: reduce dead load with lightweight aluminum
- Interior and exterior applications
- Compatible with industry standard lighting, HVAC, speaker, fire safety, and security services
- Perforated panels available for ventilation
- Factory assembled access doors available

COLORS & FINISHES

Standard colors Natural and Cotton White shown. Client-specific colors available. Minimum quantities may apply. Colors are for illustrative purposes. See page 178 for all colors and finishes.

Standard colors

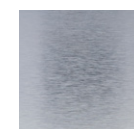

Natural



Cotton White

Custom colors



Custom

Woodwright™ finishes use our painted wood-look finish. See page 180 for all finishes.

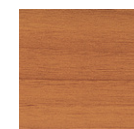

Maple

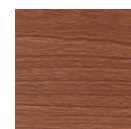

Cherry

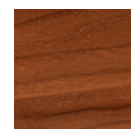

Walnut

TYPICAL SECTIONS

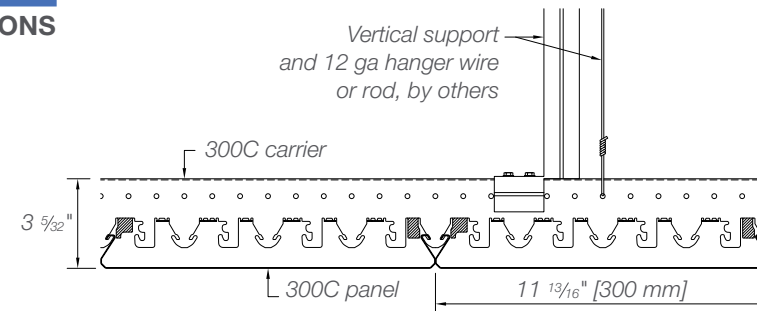

TYPICAL ISOMETRICS

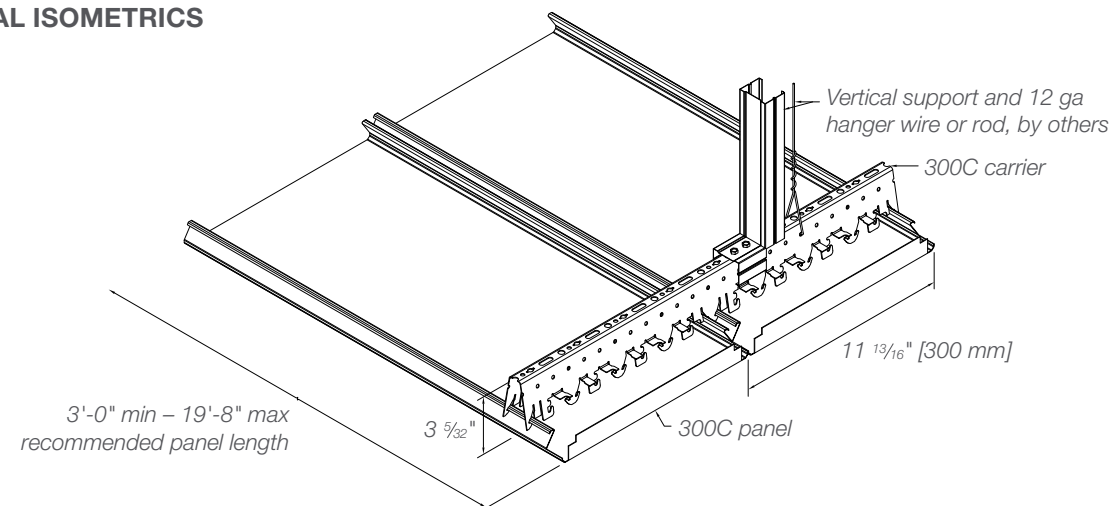

PERFORATION PATTERNS

Standard patterns shown. Scale shown: 1:1, unless otherwise noted.

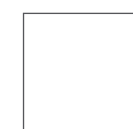

Non-perforated

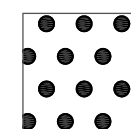

Pattern #124  
(Ventilation Panels)

PHYSICAL DATA

- Substrate:** Aluminum
- Warranty:** 1 year
- Seismic rating:** Zones A,B,C,D,E,F
- Fire rating:** Class A Fire Rated per ASTM E84
  - Painted or anodized metal: Flame spread: ≤ 25, Smoke ≤ 50
- Weight:** Varies 0.5 – 0.75 lbs./sq.ft.
- Wind load:** Per code
- Recycled content:** Up to 92%
- Light reflectance (LR) Coefficient per ASTM E1264 & ASTM E1477:**
  - Cotton White: LR = 0.81
- Acoustical ratings – NRC:** See page 190

BIM

REVIT files available for BIM contributions, see website for details.

LEED V4 CREDITS

- EA:** Optimize Energy Performance
- MR:** Building Product Disclosure
- EQ:** Low-Emitting Materials
- EQ:** Indoor Air Quality Assessment
- EQ:** Daylight

CERTIFICATIONS

GREENGUARD Gold Certified  
HPDs & EPDs – available upon request