

METAL CEILINGS

LINEAR
BOX 8 & DEEP BOX 8 SERIES

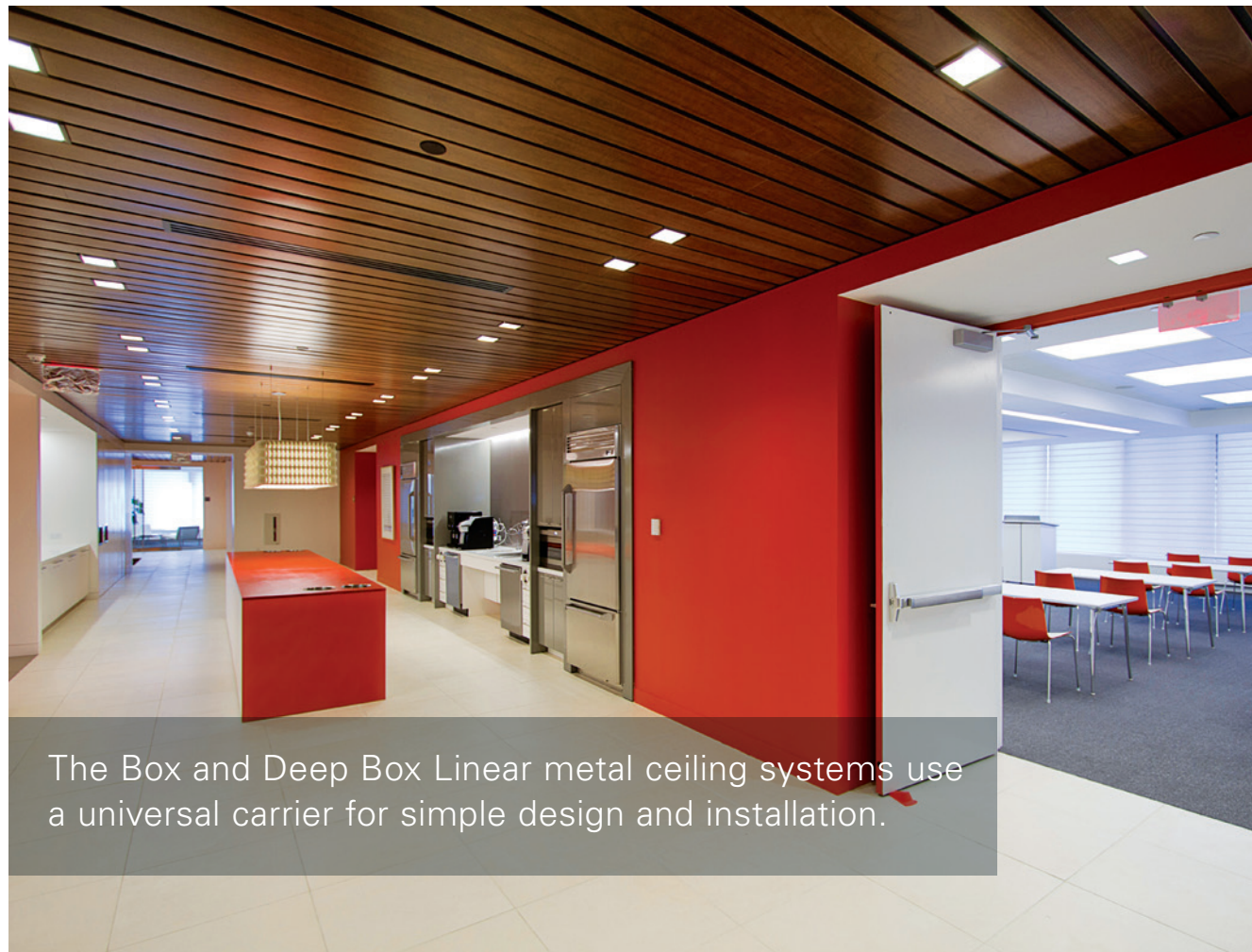

The Box and Deep Box Linear metal ceiling systems use a universal carrier for simple design and installation.

Project: Corporate Office, Pearl River, NY; Box 8

KEY FEATURES

- Panel module width: 8"
- Panel lengths: 3' to 16'
- Panel depths:
 - 5/8" (Box 8)
 - 1" (Deep Box 8)
- Square-edge design
- Curved carrier application available
- Waste reduction with factory fabricated dimensional material
- Downweight: reduce dead load with lightweight aluminum
- Easy plenum access
- Interior and exterior applications
- Compatible with industry standard lighting, HVAC, speaker, fire safety, and security services

TYPICAL SECTIONS

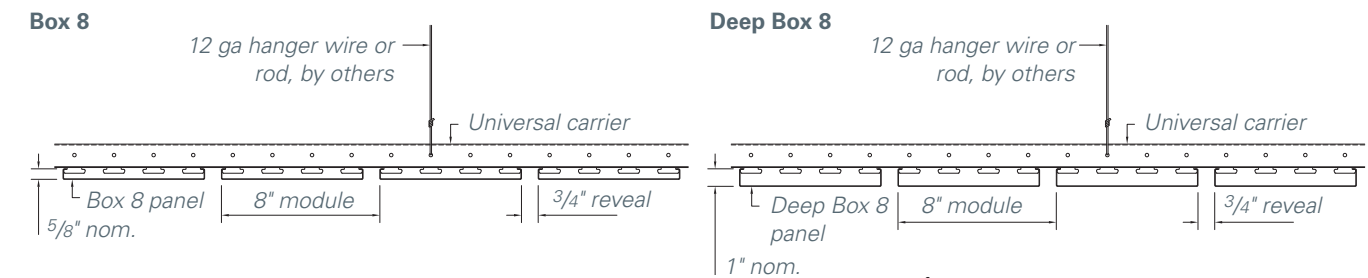

TYPICAL ISOMETRICS

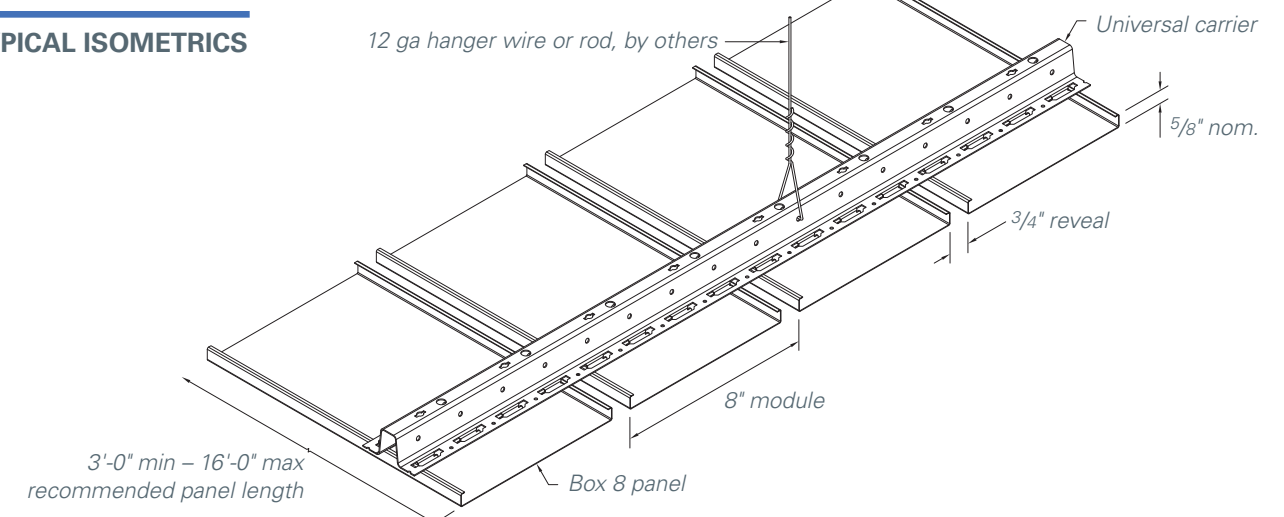

PERFORATION PATTERNS

Standard patterns shown. Perforations not available on real wood veneer. Scale shown: 1:1, unless otherwise noted.

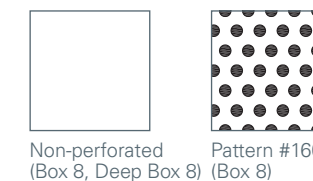

PHYSICAL DATA

Substrate: Aluminum
Warranty: 1 year
Seismic rating: Zones A,B,C,D,E,F
Fire rating: Class A Fire Rated per ASTM E84
 - Painted or anodized metal: Flame spread: ≤ 25, Smoke ≤ 50
 - Film on metal: Flame spread: ≤ 25, Smoke ≤ 50
 - Wood veneer on metal: Flame spread: ≤ 25, Smoke ≤ 55 (for interior applications)
Weight: Varies 0.5 – 1.0 lbs./sq.ft.
Wind load: Per code (for exterior applications)
Recycled content: Up to 92%
Light reflectance (LR) Coefficient per ASTM E1264 & ASTM E1477:
 - Varies with finish
 - Cotton White: LR = 0.81
Acoustical ratings – NRC: See page 240

BIM

REVIT files available for BIM contributions, see website for details.

LEED V4 CREDITS

EA: Optimize Energy Performance
 MR: Building Product Disclosure
 EQ: Low-Emitting Materials
 EQ: Indoor Air Quality Assessment
 EQ: Daylight
 EQ: Acoustic Performance

CERTIFICATIONS

GREENGUARD Gold Certified
 FSC chain of custody veneers available
 HPDs & EPDs – available upon request

METAL CEILINGS

LINEAR BOX 8 & DEEP BOX 8 SERIES

COLORS & FINISHES

Hunter Douglas offers a wide choice of colors and finishes. Some colors and finishes carry a premium price over manufacturer's standard colors. Custom color matching is available upon request. Please contact Hunter Douglas at 800-366-4327 for minimum quantities and lead times. To request samples, contact us at ceiling.samples@hunterdouglas.com. See website for the most up to date information. Colors are for illustration purposes only.

STANDARD PAINT COLORS



CUSTOM COLORS

Premium custom colors.



WHITE FINISH OPTIONS

Powder-coat paint finish for Arctic White #1015P (Gloss 10-20); Crystalline White #1050P (Gloss 45-55); Supernova White #1085P (Gloss 80-90)

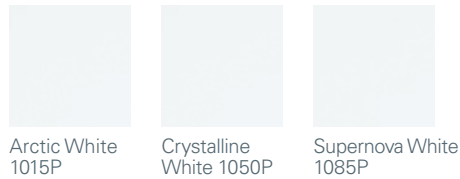

PERFORMANCE WHITE PAINT FINISH

Powder-coat paint finish offering LRV 96; non-glare, 3% low gloss finish. Certified by: Applied Technical Services, Inc. Test Report No. D233185. Test reports available by request.

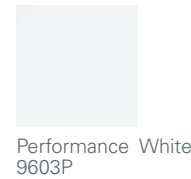

STANDARD METALLIC



Brushed Aluminum 0004

BLACK FINISH OPTIONS

Powder-coat paint finish for Starless Black #5000P (Matte); Raven Black #5030P (Gloss 25-35); Sable Black #5060P (Gloss 65-75); Wet Glass Black #5095P (Gloss 90-95)



Starless Black 5000P Raven Black 5030P Sable Black 5060P Wet Glass Black 5095P



STANDARD WOOD VENEER OPTIONS

Real wood veneer (interior only). Formaldehyde-free, Class A composite panel. Non-perforated only. Note: This is a small subset of veneers available. Please contact Hunter Douglas for client-specific species and stains.



DECORATED WOOD-LOOK OPTIONS

Powder-coat paint finish (interior and exterior). Formaldehyde-free, Class A composite panel. This finish is recommended for exterior conditions.



COIL-COATED WOOD-LOOK OPTIONS

Polyester coil-coated painted finish (interior and exterior). Formaldehyde-free, Class A composite panel. Minimums apply.

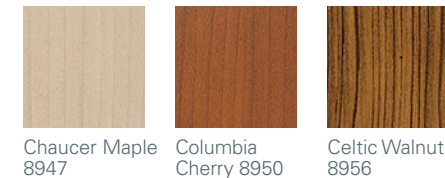

LAMINATED (FILM) WOOD FINISHES

Film (interior only). Formaldehyde-free, Class A composite panel. Minimums apply.

