

Torsion Spring – Geometries use geometrical panel shapes to create drama in the ceiling plane with a system that allows panels to swing down for plenum access.

Project: ADPRO Sports Training Facility, Orchard Park, NY; Torsion Spring – Geometries; Photo credit: Bob Perzel

**KEY FEATURES**

- Geometrically shaped panels
- Two panel size sets:
  - 6" to 30" width up to 96" long
  - 36" to 48" width up to 48" long
- Swing-down feature allows point-access and 100% access to plenum
- Square-edge design
- Waste reduction with factory fabricated dimensional material
- Downweight: reduce dead load with light-weight aluminum
- Easy installation – no fasteners/tools required
- Compatible with industry standard lighting, HVAC, speaker, fire safety, and security services

**TYPICAL ISOMETRICS**

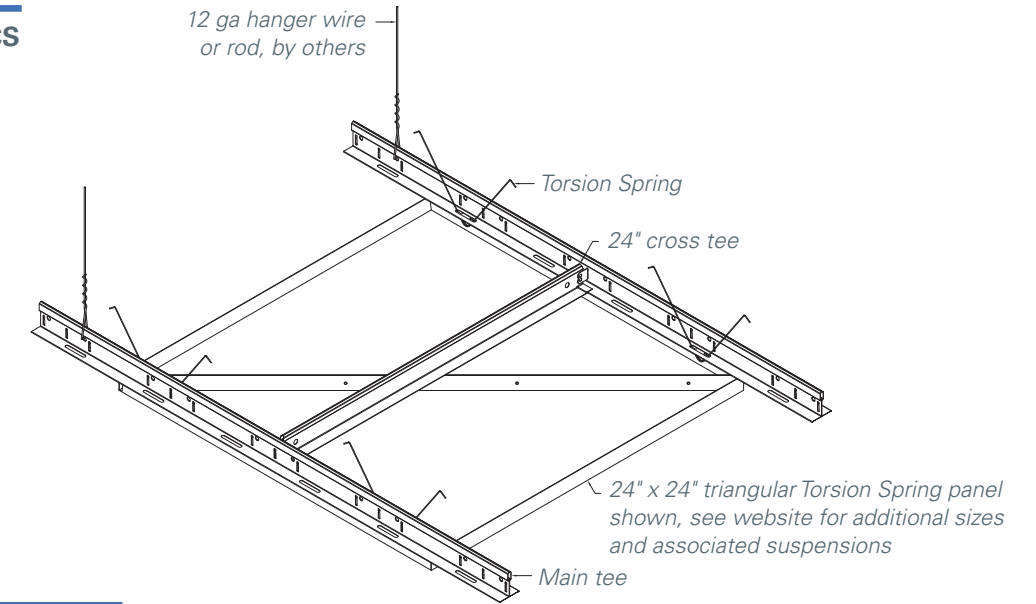

**SHAPES & CONFIGURATIONS**

Inspirational examples shown, custom shapes/configurations available.

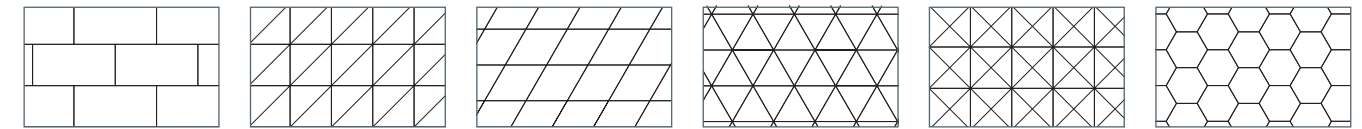

**PERFORATION PATTERNS**

Standard patterns shown. See page 238 to see all perforation patterns. Scale shown: 1:1, unless otherwise noted.

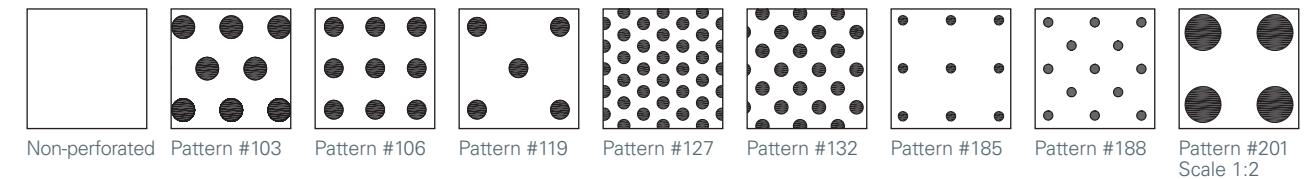

**PHYSICAL DATA**

**Substrate:** Aluminum  
**Warranty:** 1 year  
**Seismic rating:** Zones A,B,C,D,E,F  
**Fire rating:** Class A Fire Rated per ASTM E84  
 – Painted or anodized metal: Flame spread: ≤ 25, Smoke ≤ 50  
 – Film on metal: Flame spread: ≤ 25, Smoke ≤ 50  
**Weight:** Varies 1.0 – 1.6 lbs./sq.ft.  
**Wind load:** N/A  
**Recycled content:** Up to 85%  
**Light reflectance (LR) Coefficient per ASTM E1264 & ASTM E1477:**  
 – Varies with finish  
 – Cotton White: LR = 0.81  
**Acoustical ratings – NRC:** See page 240

**BIM**

REVIT files available for BIM contributions, see website for details.

**LEED V4 CREDITS**

EA: Optimize Energy Performance  
 MR: Building Product Disclosure  
 EQ: Low-Emitting Materials  
 EQ: Indoor Air Quality Assessment  
 EQ: Daylight  
 EQ: Acoustic Performance

**CERTIFICATIONS**

GREENGUARD Gold Certified  
 FSC chain of custody veneers available  
 HPDs & EPDs – available upon request



METAL CEILINGS

PLANK & TILE  
TORSION SPRING – GEOMETRIES

COLORS & FINISHES

Hunter Douglas offers a wide choice of colors and finishes. Some colors and finishes carry a premium price over manufacturer’s standard colors. Custom color matching is available upon request. Please contact Hunter Douglas at 800-366-4327 for minimum quantities and lead times. To request samples, contact us at ceiling.samples@hunterdouglas.com. See website for the most up to date information. Colors are for illustration purposes only.

STANDARD PAINT COLORS



CUSTOM COLORS

Premium custom colors.



WHITE FINISH OPTIONS

Powder-coat paint finish for Arctic White #1015P (Gloss 10-20); Crystalline White #1050P (Gloss 45-55); Supernova White #1085P (Gloss 80-90)

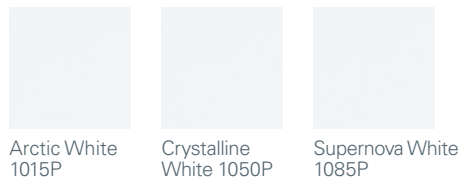

PERFORMANCE WHITE PAINT FINISH

Powder-coat paint finish offering LRV 96; non-glare, 3% low gloss finish. Certified by: Applied Technical Services, Inc. Test Report No. D233185. Test reports available by request.

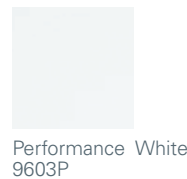

ANODIZED FINISH

STANDARD METALLIC



BLACK FINISH OPTIONS

Powder-coat paint finish for Starless Black #5000P (Matte); Raven Black #5030P (Gloss 25-35); Sable Black #5060P (Gloss 65-75); Wet Glass Black #5095P (Gloss 90-95)

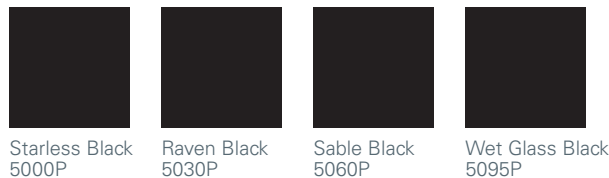

STANDARD WOOD VENEER OPTIONS

Real wood veneer (interior only). Formaldehyde-free, Class A composite panel. Note: This is a small subset of veneers available. Please contact Hunter Douglas for client-specific species and stains.



DECORATED WOOD-LOOK OPTIONS

Powder-coat paint finish (interior and exterior). Formaldehyde-free, Class A composite panel. This finish is recommended for exterior conditions.



COIL-COATED WOOD-LOOK OPTIONS

Polyester coil-coated painted finish (interior and exterior). Formaldehyde-free, Class A composite panel. Minimums apply.

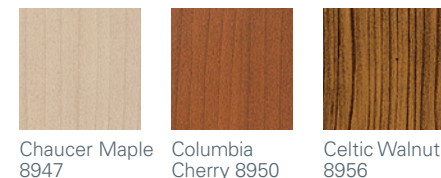

LAMINATED (FILM) WOOD FINISHES

Film (interior only). Formaldehyde-free, Class A composite panel. Minimums apply.

