

Revision: 3 Date: Nov 2013

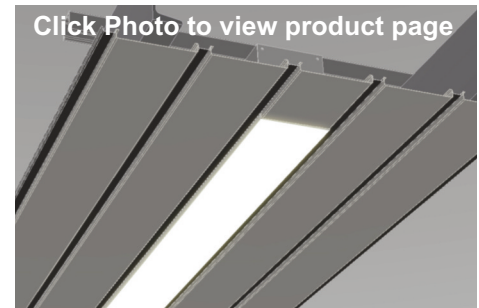

Because LED components continue to improve, click or scan QR code to view latest spec sheet.

CLICK FOR
FLUORESCENT
VERSION

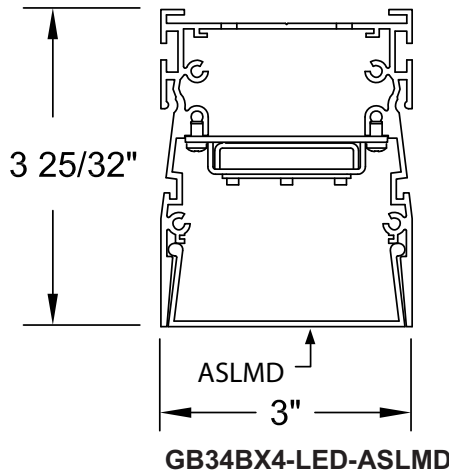

Page 2 Specifications
Page 3 Photometric Files / Lens Images
Page 5 Mounting Details

Gammalux Lighting Systems reserves the right to change details of fixture designs and construction at any time.

Product Overview (for complete specifications, see page 2)

Construction: Extruded aluminum housing is available in one piece up to 16'. Continuous runs have hairline joints with no light leak. Runs of fixtures can be built to lengths matching field conditions. Recessed into Hunter Douglas Box 4 or Deep Box 4 ceiling system.

Electrical: Gammalux products are **UL** and **cUL** listed with quick electrical connectors and LED components by OSRAM SYLVANIA. Dimming driver requires 0-10v control. Runs of fixtures are tested as a complete system prior to shipping. LED components and specifications subject to change without notice.

Continuous Illumination: LED boards are oriented to provide the most consistent illumination possible per run length.

Optical: Lenses available in standard (**ASL**), medium (**ASLMD**) and heavy diffusion (**ASLHD**) to provide varying degrees of output and reduced visibility of individual LEDs. Gammalux recommends ASLMD or ASLHD lenses because LEDs may be noticeable through standard ASL lens. See images on pages 3 and 4.

Finish/Color: High quality paint finish in high gloss or semi-gloss. Custom colors available.

Packing and Shipping: Our packing, labeling and shipping systems ensure products arrive safely, ready to install.

Standard Nomenclature

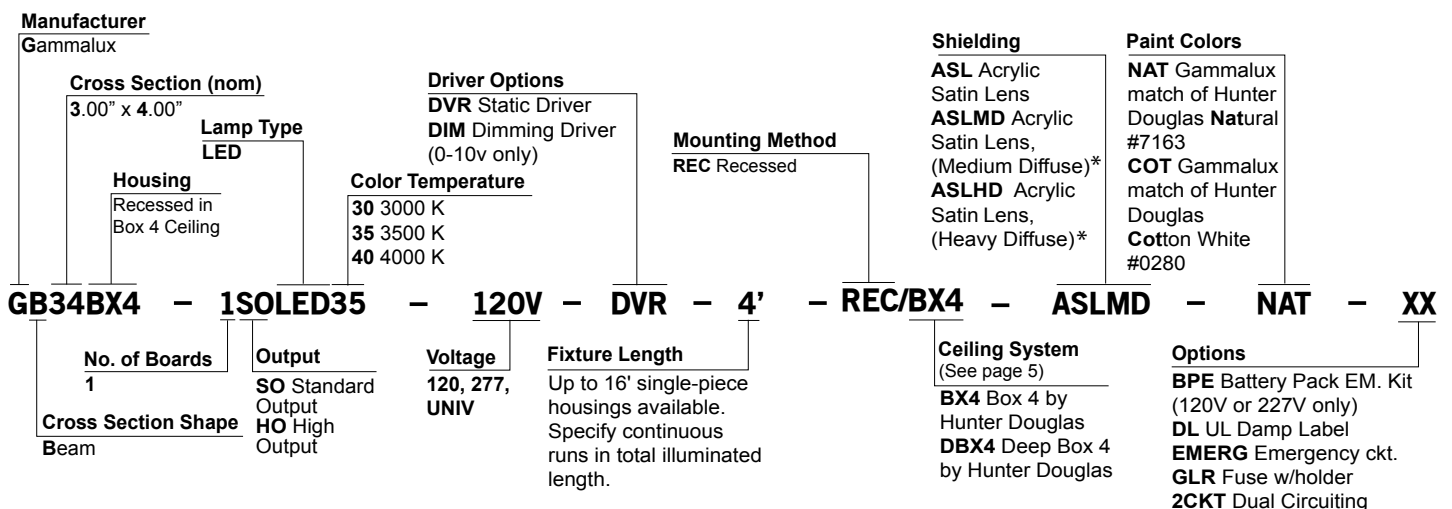

*Gammalux recommends ASLMD or ASLHD lenses because LEDs may be noticeable through standard ASL lens.



Construction

Housing: Extruded aluminum body 3.00" wide x 3.78" high, 6063T5, 0.070" minimum thickness. Available in one piece, unbroken lengths up to 16'. Runs of fixtures are built to lengths matching exact field conditions, including complex patterns. Factory-engineered drawings indicate the location of each board in continuous runs.

Joiner System: Automatic alignment, no loose parts, one tool to tighten two factory installed bolts for hairline seam. No light leaks. Fixtures that are built for continuous runs and patterns are assembled into a complete pattern and tested for fit and finish at the factory prior to being individually packed and shipped.

Mounting: Recessed into a Box 4 (specify **REC/BX4**) or Deep Box 4 (specify **REC/DBX4**) ceiling system by Hunter Douglas.

Electrical

Driver: OSRAM SYLVANIA or equal universal voltage (specify **DVR**). Fixtures with **DVR** option are wired for static use only. Dimming driver (specify **DIM**) is 0-10v dimmable constant current. Additional driver options are available (consult factory). RoSH compliant and UL listed wiring and components throughout. Housing wired with quick-connect plugs at all mating joints and individually tested. Fixtures that are built for continuous runs and patterns are assembled into a complete pattern and tested at the factory prior to being individually packed and shipped. All fixtures bear UL & cUL labels. LED components and specifications subject to change without notice.

LED Boards: OSRAM SYLVANIA or equal constant current compatible with 0-10v dimming drivers. Distributed array for even illumination, high efficacy, 80 + CRI.

LED System Lifespan: Rated for 50,000 hours at 70% lumen output (L70). Life and output based on maximum ambient temperature of 25 degrees C. 5 year limited warranty on LED components.

Continuous Illumination: LED boards are oriented to provide the most consistent illumination possible from end to end in each run built per field dimensions. Telescoping modules are not acceptable. Factory-engineered drawings indicate the location of each board in continuous runs.

Optical Performance

Acrylic Satin Lens: Shall be 15% DR acrylic (specify **ASL**).

Acrylic Satin Lens, Medium Diffuse: Shall be 15% DR acrylic (specify **ASLMD**).

Acrylic Satin Lens, Heavy Diffuse: Shall be 15% DR acrylic (specify **ASLHD**).

Performance: See charts for total lumens per foot delivered by each output and lens option.

ESTIMATED LUMENS PER FOOT DELIVERED BY COMBINATION OF LED COLOR AND LENS							
STANDARD OUTPUT LED				HIGH OUTPUT LED			
LENS OPTIONS	3000 K LEDs	3500 K LEDs	4000 K LEDs	LENS OPTIONS	3000 K LEDs	3500 K LEDs	4000 K LEDs
STANDARD DIFFUSE LENS (ASL)	563.2	574.7	597.7	STANDARD DIFFUSE LENS (ASL)	748.9	764.2	794.7
MEDIUM DIFFUSE LENS (ASLMD)	485.4	495.3	515.1	MEDIUM DIFFUSE LENS (ASLMD)	645.4	658.6	684.9
HEAVY DIFFUSE LENS (ASLHD)	316.1	322.6	335.5	HEAVY DIFFUSE LENS (ASLHD)	420.5	429.1	446.3

To obscure LED image, Gammalux recommends selection of Heavy Diffuse lens as first choice, then Medium Diffuse if additional output is necessary.
* IES files were created using 3500 K boards. Values were then adjusted by a factor of .98 for 3000 K boards and 1.04 for 4000 K boards.

Finish

Housing assembly is electrostatically sprayed with high solids aliphatic two component polyurethane to an average thickness of 2 mils. over acid etching primer. Matches of Hunter Douglas Natural # 7163 (**NAT**) and Cotton White # 0280 (**COT**) are standard. Consult with factory for other finishes.

Packing and Shipping

Fixtures built for continuous rows and patterns are given a specific location identifier, clearly identified on factory layout drawings provided to installing contractor. Location identifier is printed on the fixture's ID Label, protective wrapping and on each end of fixture carton. Shipping pallets are built with 2" clearance, extending beyond the length and width of cartons, providing shipping protection.

Approximate weight of 4' module is 12 lbs. including carton. Weight of shipping pallet and supplemental packing materials not factored in.

STANDARD OUTPUT FIXTURES

FIXTURE USES LENS ASL (STANDARD DIFFUSE) AND 3500 K BOARDS.*

IESNA: LM 79-2008
ISSUE DATE: 04/16/13
TEST: ITL76970 mod to DA 71913 @ 225 mA
TESTLAB: INDEPENDENT TESTING LABORATORIES, INC.
MANUFAC: GAMMALUX LIGHTING SYSTEMS
LUMCAT: GB34D2-SOLED35-4'-ASL

Summary Data

EFFICACY (Total): **67.4 LPW****
EFFICACY (Downlight): **67.4**
CIE CLASSIFICATION: DIRECT
LUMINOUS OPENING: RECTANGULAR
Width: 0.24 (Feet)
Length: 3.96
Height: 0.00
INPUT WATTS: 34.1



Acrylic Satin Lens
(ASL)

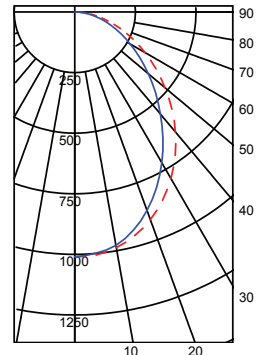
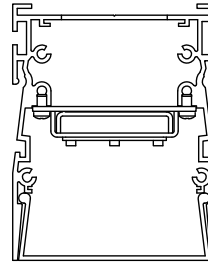

Quadrilaterally Symmetric
Dashed: 0 Degrees Solid: 90 Degrees

FIXTURE USES LENS ASLMD (MEDIUM DIFFUSE) AND 3500 K BOARDS.*

IESNA: LM 79-2008
ISSUE DATE: 04/17/13
TEST: ITL76971 mod to DA 71913 @ 225 mA
TESTLAB: INDEPENDENT TESTING LABORATORIES, INC.
MANUFAC: GAMMALUX LIGHTING SYSTEMS
LUMCAT: GB34D2-SOLED35-4'-ASLMD

Summary Data

EFFICACY (Total): **58.1 LPW****
EFFICACY (Downlight): **58.1**
CIE CLASSIFICATION: DIRECT
LUMINOUS OPENING: RECTANGULAR
Width: 0.24 (Feet)
Length: 3.96
Height: 0.00
INPUT WATTS: 34.1



Acrylic Satin Lens,
Medium Diffuse
(ASLMD)

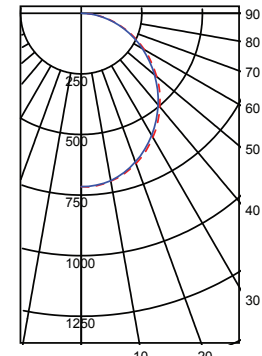
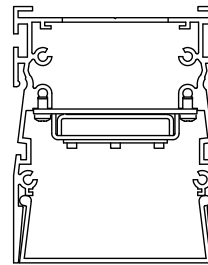

Quadrilaterally Symmetric
Dashed: 0 Degrees Solid: 90 Degrees

FIXTURE USES LENS ASLHD (HEAVY DIFFUSE) AND 3500 K BOARDS.*

IESNA: LM 79-2008
ISSUE DATE: 01/23/13
TEST: ITL76972 mod to DA 71913 @ 225 mA
TESTLAB: INDEPENDENT TESTING LABORATORIES, INC.
MANUFAC: GAMMALUX LIGHTING SYSTEMS
LUMCAT: GB34RC-SOLED35-4'-ASLHD

Summary Data

EFFICACY (Total): **37.8 LPW****
EFFICACY (Downlight): **37.8**
CIE CLASSIFICATION: DIRECT
LUMINOUS OPENING: RECTANGULAR
Width: 0.24 (Feet)
Length: 3.96
Height: 0.00
INPUT WATTS: 34.1



Acrylic Satin Lens,
Heavy Diffuse
(ASLHD)

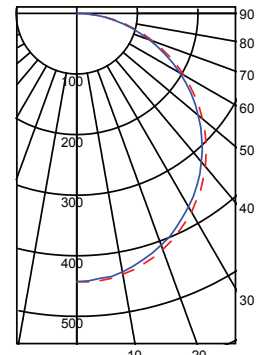
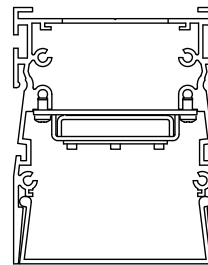

Quadrilaterally Symmetric
Dashed: 0 Degrees Solid: 90 Degrees

* See performance notes, page 2.

IES files were created using 3500 K boards. When using calculation programs, multiply lumen output or set correction factor to .98 for 3000 K boards and 1.04 for 4000 K boards. **Efficacy is a measure of lumens per watt, as delivered through the fixture aperture.

FIXTURE USES LENS ASL (STANDARD DIFFUSE) AND 3500 K BOARDS.*

IESNA: LM 79-2008
ISSUE DATE: 04/16/13
TEST: ITL76970 mod to DA 71913 @ 300 mA
TESTLAB: INDEPENDENT TESTING LABORATORIES, INC.
MANUFAC: GAMMALUX LIGHTING SYSTEMS
LUMCAT: GB34D2-HOLED35-4'-ASL

Summary Data

EFFICACY (Total): **62.6 LPW****
EFFICACY (Downlight): **62.6**
CIE CLASSIFICATION: DIRECT
LUMINOUS OPENING: RECTANGULAR
Width: 0.24 (Feet)
Length: 3.96
Height: 0.00
INPUT WATTS: 48.8



Acrylic Satin Lens
(ASL)

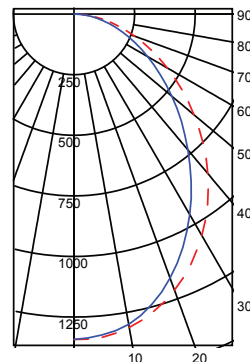
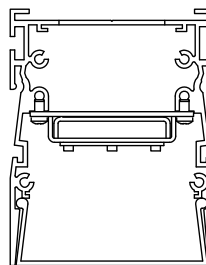

Quadrilaterally Symmetric
Dashed: 0 Degrees Solid: 90 Degrees

FIXTURE USES LENS ASLMD (MEDIUM DIFFUSE) AND 3500 K BOARDS.*

IESNA: LM 79-2008
ISSUE DATE: 04/17/13
TEST: ITL76971 mod to DA 71913 @ 300 mA
TESTLAB: INDEPENDENT TESTING LABORATORIES, INC.
MANUFAC: GAMMALUX LIGHTING SYSTEMS
LUMCAT: GB34D2-HOLED35-4'-ASLMD

Summary Data

EFFICACY (Total): **53.9 LPW****
EFFICACY (Downlight): **53.9**
CIE CLASSIFICATION: DIRECT
LUMINOUS OPENING: RECTANGULAR
Width: 0.24 (Feet)
Length: 3.96
Height: 0.00
INPUT WATTS: 48.8



Acrylic Satin Lens,
Medium Diffuse
(ASLMD)

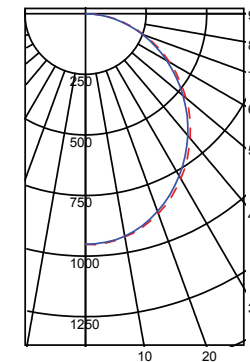
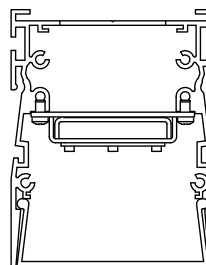

Quadrilaterally Symmetric
Dashed: 0 Degrees Solid: 90 Degrees

FIXTURE USES LENS ASLHD (HEAVY DIFFUSE) AND 3500 K BOARDS.*

IESNA: LM 79-2008
ISSUE DATE: 04/18/13
TEST: ITL76972 mod to DA 71913 @ 300 mA
TESTLAB: INDEPENDENT TESTING LABORATORIES, INC.
MANUFAC: GAMMALUX LIGHTING SYSTEMS
LUMCAT: GB34D2-HOLED35-4'-ASLHD

Summary Data

EFFICACY (Total): **35.2 LPW****
EFFICACY (Downlight): **35.2**
CIE CLASSIFICATION: DIRECT
LUMINOUS OPENING: RECTANGULAR
Width: 0.24 (Feet)
Length: 3.96
Height: 0.00
INPUT WATTS: 48.8



Acrylic Satin Lens,
Heavy Diffuse
(ASLHD)

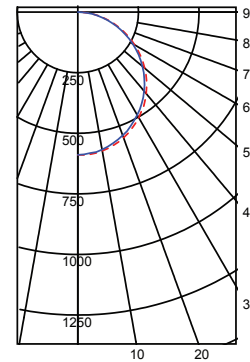
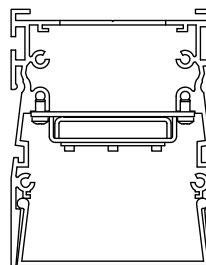

Quadrilaterally Symmetric
Dashed: 0 Degrees Solid: 90 Degrees

* See performance notes, page 2.

IES files were created using 3500 K boards. When using calculation programs, multiply lumen output or set correction factor to .98 for 3000 K boards and 1.04 for 4000 K boards. **Efficacy is a measure of lumens per watt, as delivered through the fixture aperture.

Factory Drawings: Fully dimensioned factory drawings will be provided upon receipt of purchase order.

Box 4 Ceiling:

Specify **BX4** code in catalog #

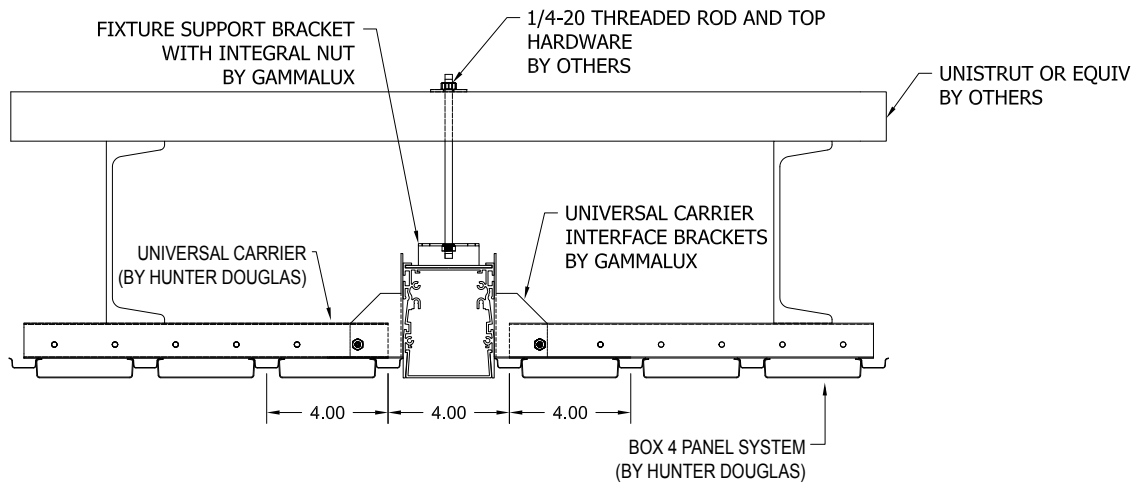

Deep Box 4 Ceiling:

Specify **DBX4** code in catalog #

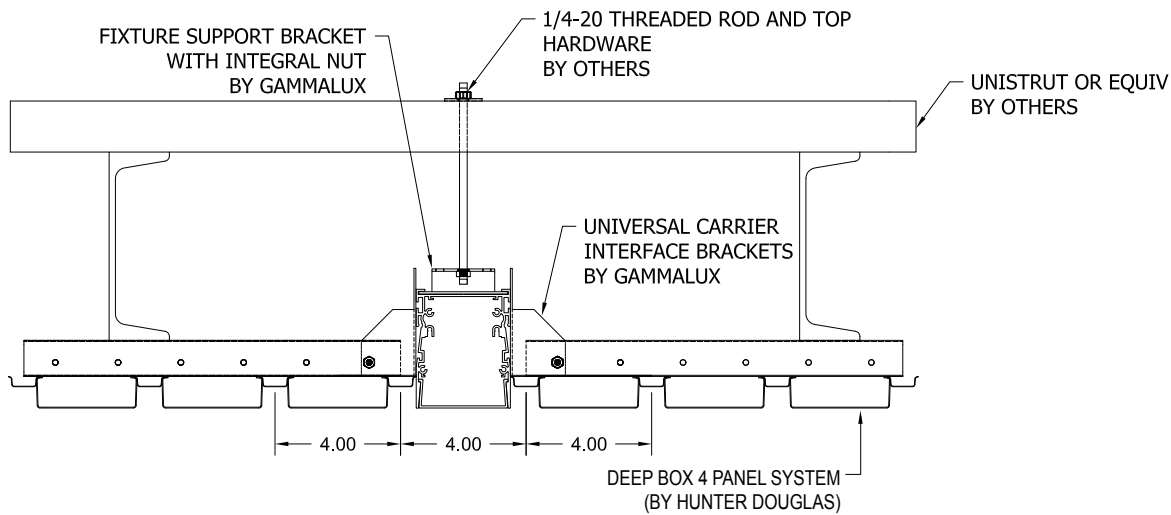

Mounting bracket is field adjustable to accommodate Box 4 or Deep Box 4 conditions.

Gammalux Lighting Systems reserves the right to change details of fixture design and construction at any time.