

H282 2" Aluminum Horizontal Blinds

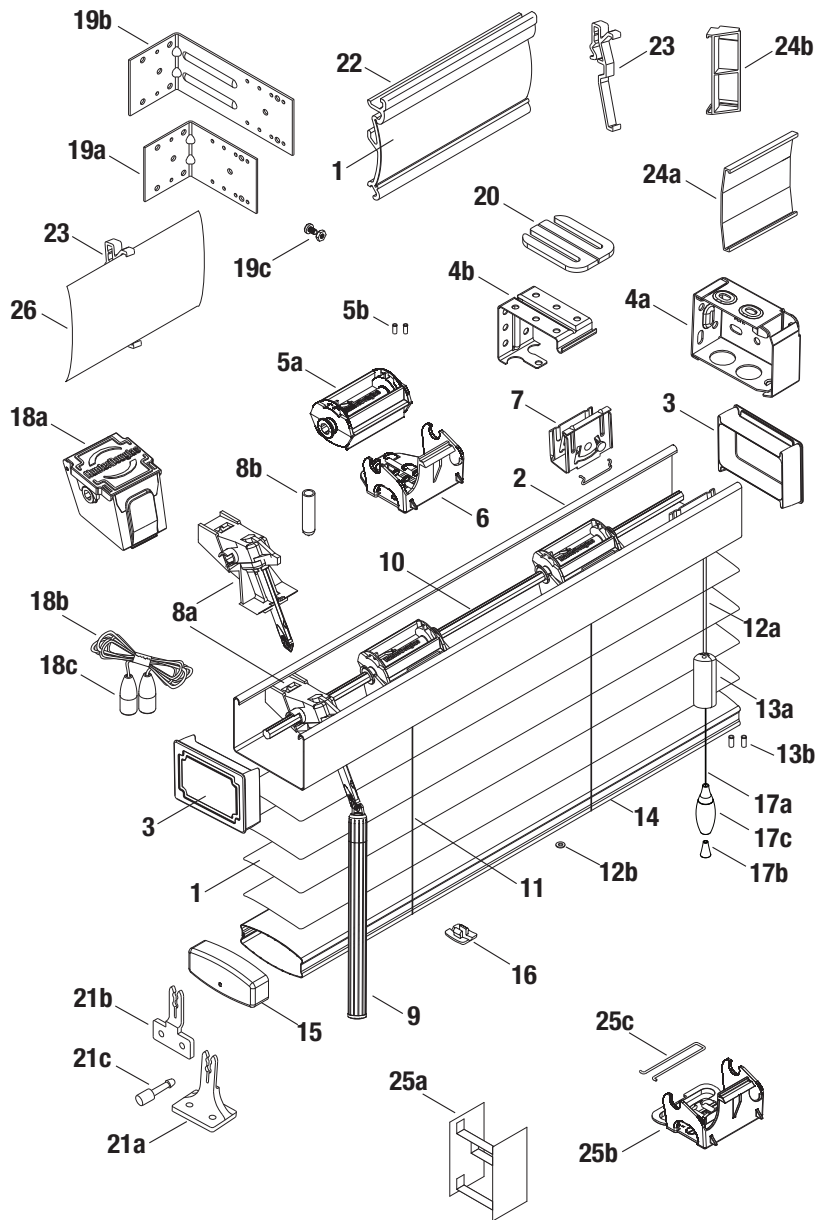

STANDARD COMPONENTS:

1. Slat
2. Headrail
3. Headrail End Cap
- 4a. Installation Bracket
- 4b. Intermediate Support Bracket
- 5a. Universal Tape Roll
- 5b. Cable Tape Grommet
6. Tape Roll Support – Ladder
7. Cordlock
- 8a. Wand Tilter
- 8b. Tilter Protector
9. Wand
10. Tiltrod
11. Cable Tape
- 12a. Lift Cord 1.4mm
- 12b. Lift Cord Grommet
- 13a. Cord Stop
- 13b. Safety Tassel Grommet
14. Bottom Rail
15. Bottom Rail End Cap
16. Tape Button
- 17a. Tassel Cord
- 17b. Conical Tassel Washer
- 17c. Tassel

OPTIONAL COMPONENTS:

- 18a. Cord Tilter
- 18b. Tilt Cord 1.4mm
- 18c. Tilter Tassels
- 19a. Short Extension Bracket
- 19b. Long Extension Bracket
- 19c. Extension Bracket Screw and Nut
20. Bracket Shim
- 21a. Hold-Down Bracket (Sill)
- 21b. Hold-Down Bracket (Jamb)
- 21c. Hold-Down Pin
22. Optional Valance
23. Valance Clip
- 24a. Valance Splice
- 24b. Valance Corner Clip
- 25a. Decorative Ladder Tape
- 25b. Tape Roll Support – Decorative Tape
- 25c. Decorative Tape Pin
26. Standard Valance