

HunterDouglas

Installation • Operation • Care



Provenance[®] Woven Wood Shades
Standard Cordlock

CONTENTS

Getting Started:

Product View	1
Tools and Fasteners Needed	2

Installation:

Installation Overview	3
Mount the Standard Installation Brackets — Inside Mount.....	4
Mount the Standard Installation Brackets — Ceiling Mount	4
Mount the Standard Installation Brackets — Outside Mount	5
Mount the Turned Headrail	6
Install the Shade	7
Attach the Optional Components.....	8

Operation:

Operate the Shade	9
Troubleshooting	10

Care:

Removing the Shade	11
Cleaning Procedures	12

Child Safety:

Child Safety Warning	13
----------------------------	----

Questions?

Contact a Customer Service representative at

1-800-727-8953.



Product View

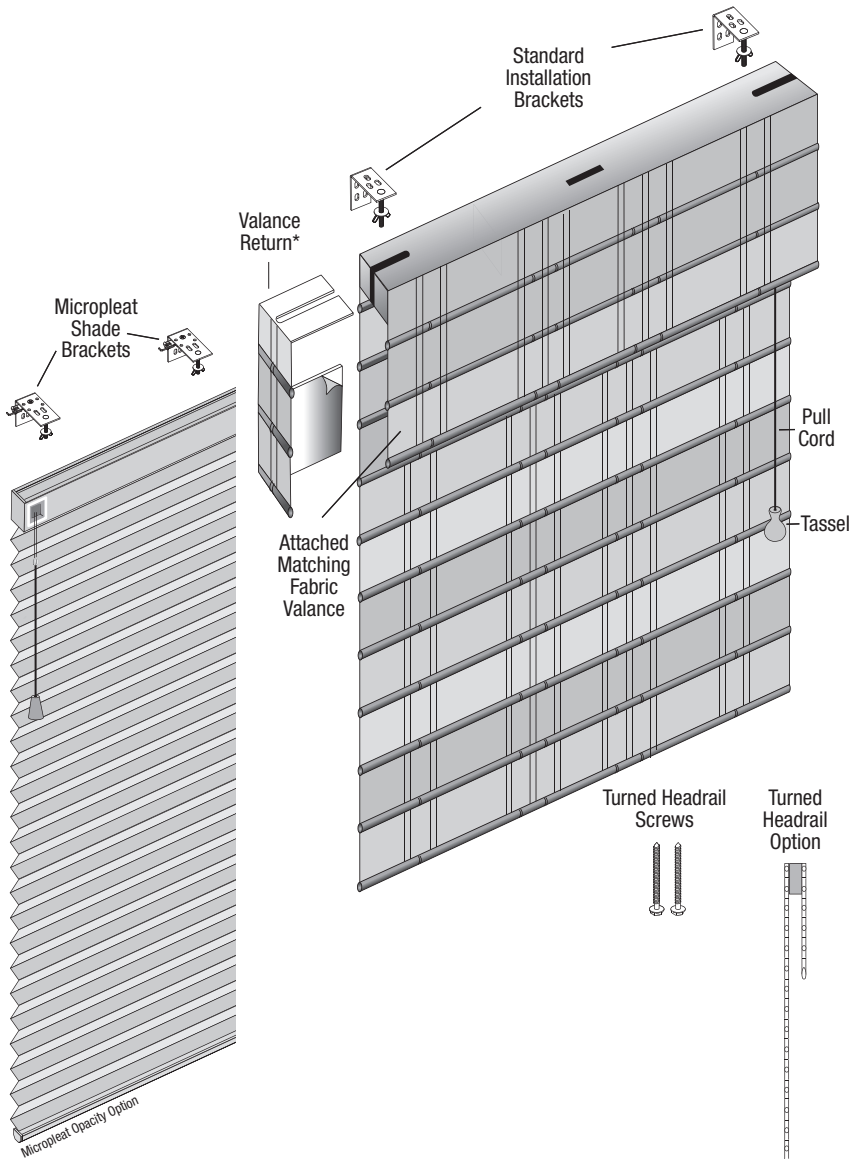

*Valance returns are standard on outside mount shades and optional on inside mount shades.

GETTING STARTED

Thank you for purchasing Hunter Douglas Provenance® Woven Wood Shades. With proper installation, operation, and care, your new shades will provide years of beauty and performance. Please thoroughly review this instruction booklet and the enclosed packing list before beginning the installation.

Tools and Fasteners Needed

- Flat blade and Phillips screwdrivers
- Measuring tape and pencil
- Level (laser level is recommended)
- Power drill, $\frac{3}{16}$ " drill bit, $\frac{3}{32}$ " drill bit, and $\frac{1}{4}$ " hex driver

In addition, you will need fasteners designed to work with your specific mounting surface(s).

- **#6 Hex Head Screws (Provided).** Two $1\frac{1}{2}$ " screws are provided per installation bracket.
- **#8 Hex Head Screws (Provided with Turned Headrail Option).** $2\frac{1}{2}$ " and 3" screws are provided for wall or ceiling mount.
- **Drywall Anchors (Not Provided).** Use drywall anchors when mounting into drywall.



#6 x $1\frac{1}{2}$ "
Hex Head Screw
(Provided)



#8 x $2\frac{1}{2}$ " or 3"
Hex Head Screw
(Provided)

Installation Overview

■ One of the following bracket types are required depending on shade options ordered. The number of brackets required varies with shade width, as shown in the table below.

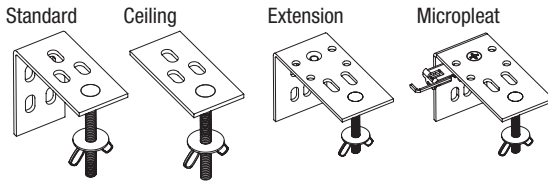

Width	Brackets Required
18" – 36"	2
36 1/8" – 72"	3
72 1/8" – 96"	5
2- or 3-on-1 Headrail	5

Mounting Types and Window Terminology

If the installation brackets are mounted correctly, the rest of the installation process follows easily. To prepare for this important first step, review the mounting types and basic window terminology.

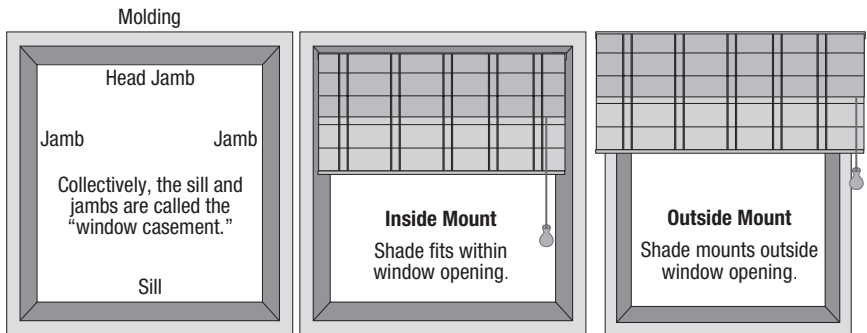

■ Refer to the appropriate page below based on your order:

- **Standard Shades – Inside Mount — Page 4**
- **Standard Shades – Ceiling Mount — Page 4**
- **Standard Shades – Outside Mount — Page 5**
- **Turned Headrail Shades — Page 6**

INSTALLATION

Mount the Standard Installation Brackets — Inside Mount

- Mark 1" in from each jamb.
- If more than two installation brackets came with your order, space additional bracket(s) evenly between the two end brackets and mark their location. Mount into wood whenever possible.

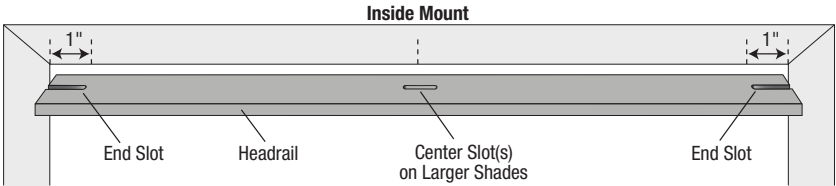

- Center the brackets on your marks, then mark each of the screw holes.
- Minimum mounting depth for bracket attachment is 1½". Fully recessed mounting depth is 2¼".

NOTE: Adjust bracket placement to gain clearance to avoid any obstructions, such as window cranks or handles.

IMPORTANT: The front edges of the installation brackets must be level and aligned.

- Drill the screw holes using a 3/32" drill bit.
- Attach the installation brackets using the screws provided.

IMPORTANT: Use drywall anchors when mounting into drywall.

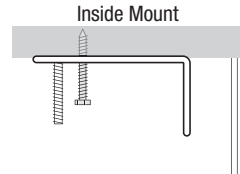

Proceed to "Install the Shade" on page 7.

Mount the Standard Installation Brackets — Ceiling Mount

- Center each bracket over your marks on the mounting surface.
- Drill the screw holes using a 3/32" drill bit.
- IMPORTANT:** Use drywall anchors when mounting into drywall.
- Attach using two screws through the top holes.
- The shade must be mounted level to operate properly. Use a level to ensure that all brackets are level and aligned. Shim the brackets, if necessary.

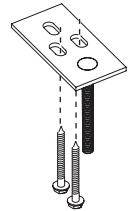

Proceed to "Install the Shade" on page 7.

Mount the Standard Installation Brackets — Outside Mount

- Center the headrail over the window opening at the desired height. Use a pencil to lightly mark each end of the headrail.
 - Alternatively, measure the width of the headrail and use that width to mark the headrail end points over the window opening.
- Mark 1" in from each end of the headrail.
 - If more than two installation brackets came with your order, space additional bracket(s) evenly between the two end brackets and mark their location. Mount into wood whenever possible.

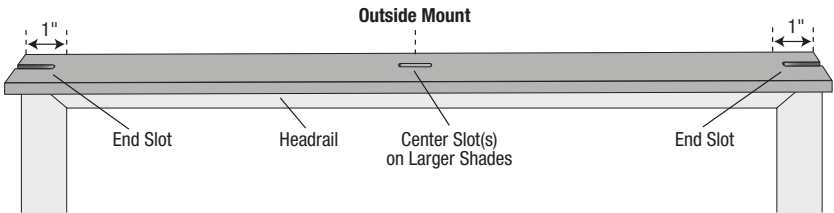

- Center the brackets on your marks, then mark each of the screw holes.
 - A minimum 17/8" flat vertical surface is required to mount the brackets.
 - The top of the installation bracket should be at the desired shade height.

IMPORTANT: The brackets should be level and aligned.

CAUTION: The rear of the brackets must be flush against a flat mounting surface. Do not mount brackets on a curved molding.

- Drill the screw holes using a 3/32" drill bit.
- Attach the installation brackets using the screws provided.

IMPORTANT: Use drywall anchors when mounting into drywall.

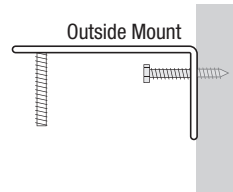

Proceed to "Install the Shade" on page 7.

INSTALLATION

Mount the Turned Headrail

Inside/Ceiling Mount

- Hold the turned headrail in place.
- Press a headrail screw through each drilled hole in the headrail to mark the screw holes.
- Drill the screw holes using a $\frac{3}{32}$ " drill bit.
IMPORTANT: Use drywall anchors when mounting into drywall.
- Attach the headrail to the mounting surface with the screws provided.

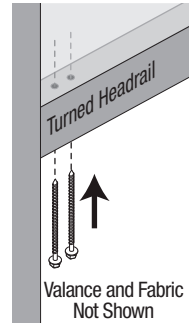

Outside Mount

- Measure the headrail width. Use the chart as a reference of the number of screws needed for your shade.
 - Screws will be used in pairs with an inch between the pair of screws.
- Lift the valance and mark the headrail $1\frac{1}{2}$ " in from each end for the first screw in the pair.

Width	Turned Headrail Screws
18" – 36"	4
36 $\frac{1}{8}$ " – 72"	6
72 $\frac{1}{8}$ " – 96"	10
2- or 3-on-1 Headrail	10

- IMPORTANT:** Avoid drilling through the vertically oriented yarns on the shade fabric.
 - Mark an inch from your mark for the location of the next screw in the pair.

- Mark the location of each pair of screws spaced evenly between the two end pairs. Mount into wood whenever possible.
- Drill the screw holes in the headrail and on the mounting surface using a $\frac{3}{16}$ " drill bit.

IMPORTANT: Use drywall anchors when mounting into drywall.

- Attach the headrail to the mounting surface using the screws provided.

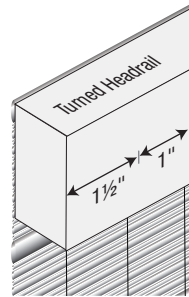

Install the Shade

If you ordered a Micropleat Liner...

- Hold the liner so the lift cords face you.
- Place the top of the liner headrail up into the bracket.
- Push up on the headrail and close the latch on the bracket to lock the shade into place. Follow the installation steps below to install the shade.

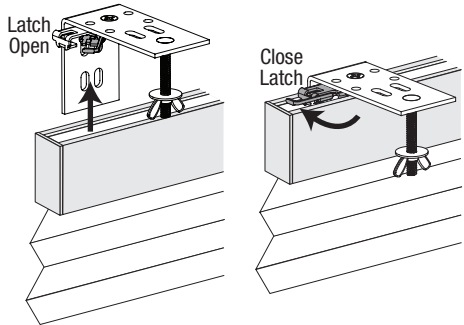

Standard Shades

- Align the studs on the installation brackets with the slots in the headrail of the shade.
- Place the wing nuts onto the studs and tighten them about 1/2".
- If valance returns are included, slide the valance return between the headrail and the brackets.
- Tighten the wing nuts completely.
- Check that the brackets securely hold the shade and valance returns.

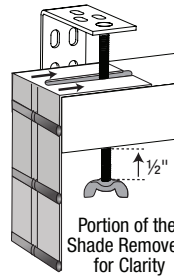

INSTALLATION

Attach the Optional Components

If You Ordered Valance Returns...

- Remove the paper from the pressure sensitive tape on the valance returns. Smooth the valance down the sticky portion of the tape.

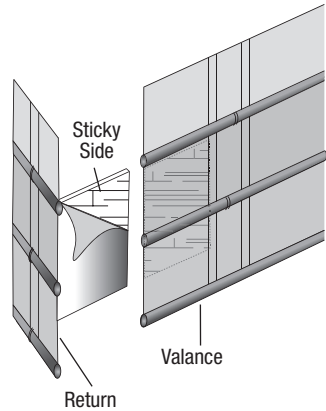

If You Ordered Hold-Down Brackets...

Hold-down brackets provide stability and prevent swaying by securing the bottom rail — for example, in French door applications. Hold-down brackets can only be used with outside mount shades.

- Lower the shade and place the pins from the hold-down brackets into the bottom rail end caps.
- On the mounting surface, mark the screw holes.
- Drill the screw holes using a $\frac{3}{32}$ " drill bit.
- Attach the hold-down brackets to the mounting surface using the screws provided.

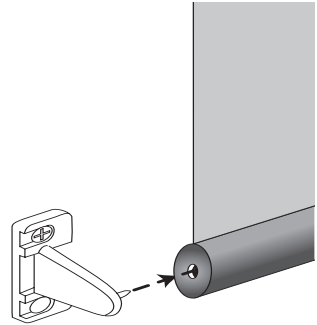

Operate the Shade

Standard Shades

To raise the shade:

- Hold the cord and pull until the shade is at the desired height.
- Pull the cord towards the outside of the shade to lock into position.

To lower the shade:

- Pull the cord towards the inside of the shade to unlock.
- Holding the cord, let the shade lower to the desired height.
- Pull the cord towards the outside of the shade to lock.

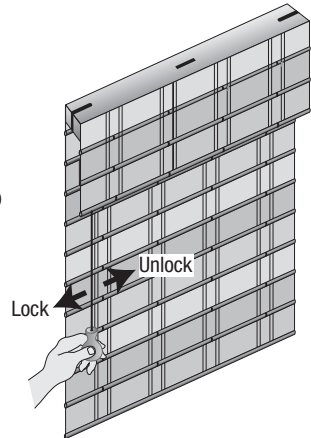

Shades with Micropleat Liner

To raise the Micropleat liner:

- Pull the cord straight down until the Micropleat liner is at the desired height.
- Release the cord to lock.

To lower the Micropleat liner:

- Pull the cord straight down to release the lock.
- Holding the cord, let the liner lower to the desired height.
- Tug the cord slightly on the cord to lock.
- Release the cord.

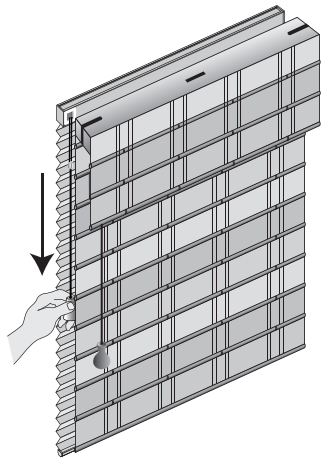

Troubleshooting

Problem	The shade will not fit into the installation brackets.
Solution	<p>Check that the installation brackets are level and aligned. Shim the installation brackets to level the headrail, if necessary. Shims are provided.</p> <p>Be sure the heads of the screws are flush against the installation bracket.</p> <p>Check that the headrail is completely inserted into the installation brackets. See “Install the Shade” on page 7.</p>
Problem	The shade is hard to raise or lower, or will not raise or lower.
Solution	<p>Make sure that the shade fabric is not caught between the installation bracket and the headrail.</p> <p>Check that the headrail and installation brackets are level and aligned. Shim the installation brackets to level the headrail, if necessary.</p> <p>If hold-down brackets are used, make sure they have been released before operating the shade.</p>
Problem	The shade raises or lowers unevenly or the bottom rail is uneven when fully raised.
Solution	<p>Check that the headrail and installation brackets are level and aligned. Shim the installation brackets to level the headrail, if necessary.</p> <p>Check to see if there is an obstruction in the shade’s path. If a shade hits an obstruction as it is lowered, it may become misaligned. This may cause the shade to be angled or tilted when fully raised. Try lowering the shade completely, then raising it to allow it to self-correct.</p>

Removing the Shade

Standard Shade

- Fully raise the shade.
- While holding the headrail, remove each wing nut from all screws on the brackets.
- If your shade has a turned headrail, remove the screws.

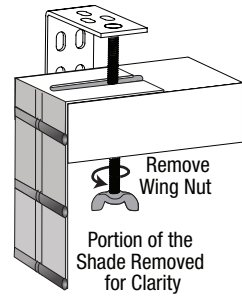

Micropleat Liner

- Fully raise the liner.
- Hold the liner.
- Open the latch on the Micropleat bracket to unlock the liner.

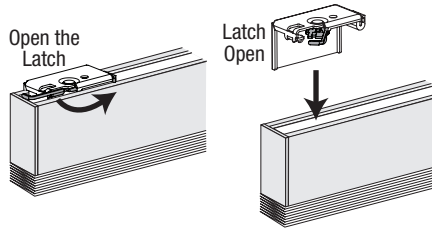

Cleaning Procedures

For most fabrics, the following options are available if your shade needs cleaning.

Dusting

- Regular light dusting with a feather duster is all the cleaning that is needed in most circumstances. You may also use a hair dryer on a cool setting or compressed air set to a low pressure.

Vacuuuming

- Use a low suction, hand-held vacuum for more thorough dust removal.

Spot-Cleaning

Only the following Provenance® fabrics can be spot-cleaned:

- Adelaide
- Aspen
- Brisbane
- Camden
- Coastal
- Colfax
- Corner Market
- Janipur
- Kathay
- Kiawah
- Mindanao
- Montana
- Nantucket™
- Palisade
- Safari
- Samoa
- Shoal Bay
- Thailand
- Duo Color Liners

- Prepare a solution of warm water and a mild detergent.
- Dampen a clean cloth in the solution and wring it out.
- Dab the spot with the dampened cloth until it is gone. Do not rub the fabric.
- Allow the shade to dry in the completely lowered position.



WARNING

For more safety information call 1-888-501-8364 in the U.S. or 1-866-662-0666 in Canada.

Young children can **STRANGLE** in cord loops above the cord stop. They can also wrap cords around their necks and **STRANGLE**.

- Always keep cords out of the reach of children.
- Move cribs, playpens and other furniture away from cords. Children can climb furniture to get to cords.
- Do not tie cords together. Make sure cords do not twist together and create a loop.

Hunter Douglas provides cord cleats and we recommend their use.

- Attach two cord cleats 6" to 12" apart at a height where they will be out of the reach of children. Take into account that a child may stand on furniture attempting to reach the cords. Be sure the cleats are firmly secured. Once the cleats are attached, wrap excess cord around them after each use of the shade.
- Only Hunter Douglas supplied hardware should be used. Replacement parts may be obtained by contacting the Hunter Douglas Customer Information Center at 1-888-501-8364.



NOTE: The warning labels on the bottom rails of corded window coverings contain important safety information. These warning labels are designed to be permanent, in accordance with the industry's safety standards, and must not be removed.