

HunterDouglas

Installation • Operation • Care



Silhouette[®] and Nantucket[™] Window Shadings

EasyRise[™], LiteRise[®], and UltraGlide[®] 2 Click and
Walk Away[™] Lifting Systems

CONTENTS

Getting Started:

Product View	1
Tools and Fasteners Needed	2

Installation:

Installation Overview	3
Mount the Installation Brackets — Inside Mount	4
Mount the Installation Brackets — Outside Mount	6
Mount the Installation Brackets — End Mount	8
Install the Shading	9
Attach the Universal Cord Tensioner (UCT) for EasyRise™ Only	9
Final Adjustments.....	10

Operation:

Operate the Shading	13
Troubleshooting	16

Care:

Removing the Shading.....	20
Cleaning Procedures	20

Child Safety:

Warning	22
Cord Loop Shadings.....	22

Questions?

Contact a Customer Service representative at
1-800-727-8953.



Product View

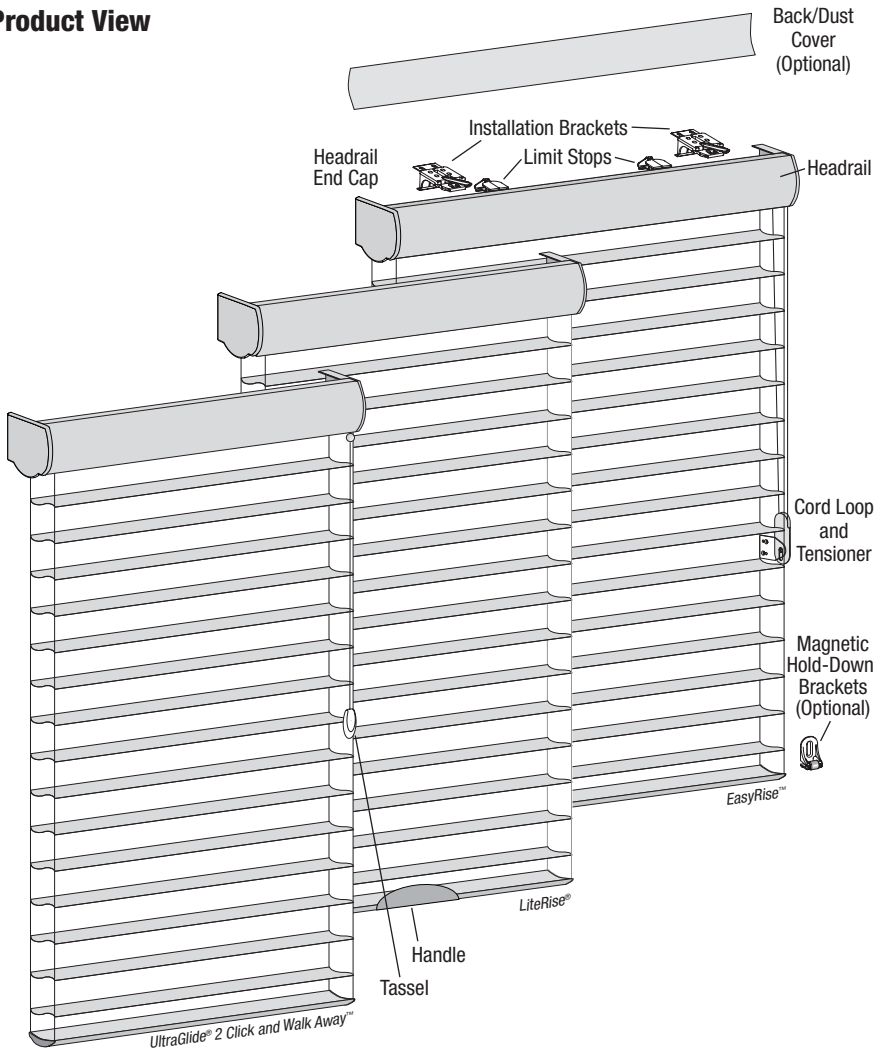

Two-On-One Headrail Shading

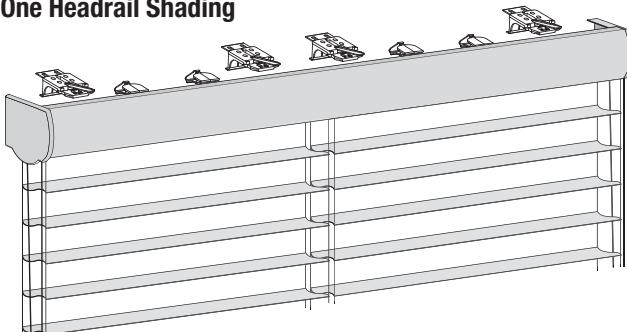

GETTING STARTED

Thank you for purchasing Hunter Douglas Silhouette® or Nantucket™ window shadings. With proper installation, operation, and care, your new shadings will provide years of beauty and performance.

Please thoroughly review this instruction booklet and the enclosed packing list before beginning the installation. If your shading has a protective plastic cover on the fabric-covered headrail, keep the plastic in place until the shading is installed.

Tools and Fasteners Needed

- Flat blade and Phillips screwdrivers
- Measuring tape and pencil
- Power drill, $\frac{3}{32}$ " drill bit, and $\frac{1}{4}$ " hex driver
- Level (laser level is recommended)
- Pliers
- Scissors (heavy-duty)

In addition, you will need fasteners designed to work with your specific mounting surface(s).

- **#6 Hex Head Screws (Provided).** Two $1\frac{1}{2}$ " screws are provided per installation bracket.
- **Longer #6 Hex Head Screws (Not Provided).** If using spacer blocks, use #6 screws long enough for a secure attachment.
- **Speed Nuts and Screws (Provided).** Extension brackets come with screws and speed nuts.
- **Drywall Anchors (Not Provided).** Use drywall anchors when mounting into drywall.

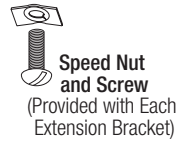
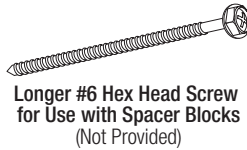

Importance of Limit Stops on Silhouette and Nantucket Window Shadings

Limit stops serve as the upper travel limit for the bottom rail, preventing it from rotating around the fabric roll. Limit stops are located 6" from the ends of the headrail or are centered on shadings less than 36" wide.

When a shading is made, the limit stops are adjusted according to the size of the fabric roll. Occasionally, this adjustment changes during shipping or installation. If this happens, problems can be fixed by readjusting the limit stops. See page 17 in the Troubleshooting section if shading operation is difficult or if the bottom rail rotates around the fabric roll. Shown below are the four possible positions of limit stops for large to small fabric rolls.

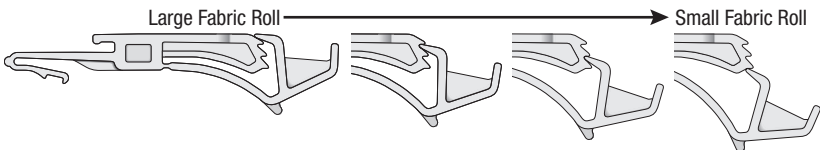

Installation Overview

- Your order will include the correct number of installation brackets for your shading width, as shown in the table below.
- Shading orders may also include spacer blocks or extension brackets, if they were specified for added clearance.
 - Extension brackets are used for end mount shadings, as well.

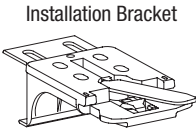

Shading Width	Brackets
14" – 36"	2
36 ¹ / ₈ " – 79"	3
79 ¹ / ₈ " – 96"	4
96 ¹ / ₈ " – 120"	5

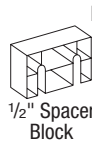

For Added Clearance

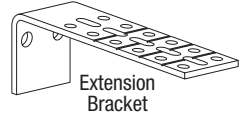

- **Two-On-One Headrail Shadings.** The appropriate number of brackets are provided for each panel.

NOTE: UltraGlide® 2 shadings come with a shipping clip installed to keep the tassel cord in place. Do not remove the clip until the headrail is installed.

Mounting Types and Window Terminology

If the installation brackets are mounted correctly, the rest of the installation process follows easily. To prepare for this important first step, review the mounting types and basic window terminology illustrated below.

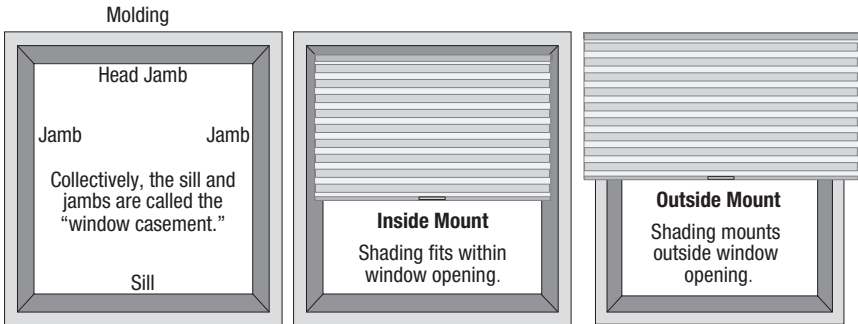

- Refer to the appropriate page below based on your order:
 - **Inside Mount — Page 4**
 - **Outside Mount — Page 6**
 - **End Mount — Page 8**

INSTALLATION

Mount the Installation Brackets — Inside Mount

Prepare the Installation Brackets

- **If using the optional back cover:** Use pliers or heavy duty scissors to remove both the top and bottom tabs on the installation brackets.
 - Then remove the top tab on the back cover brackets.
 - Snap the prongs on the back cover brackets into the holes on the back of the installation brackets.
- **If not using the optional back cover:** Remove the top tab only on the installation brackets.

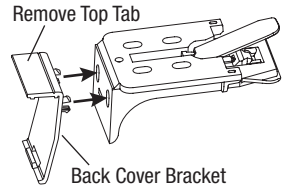
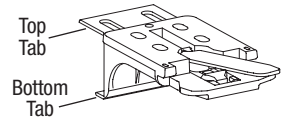

NOTE: Save these tabs once removed. They may be used as shims, if necessary.

Mount the Installation Brackets

- Mark 2" to 3" from each jamb for bracket location.
 - If more than two installation brackets came with your order, space additional bracket(s) evenly between the two end brackets and mark their location. Mount into wood whenever possible.

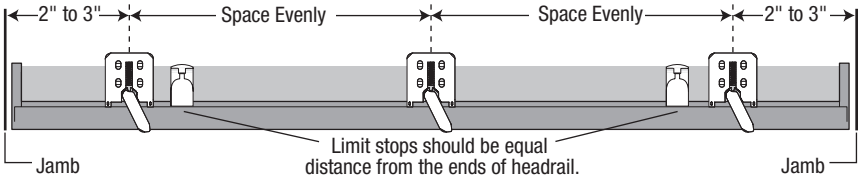

- **Two-On-One Headrail Shadings.** Place the installation brackets as shown in the illustration below.

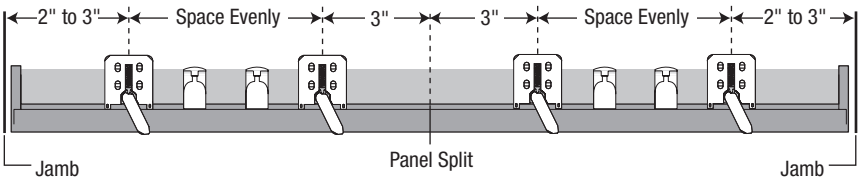

- Decide whether the front or back set of installation bracket holes works best in your application. Mark the location of the screw holes.
- The depth required for fully recessed mounting will vary depending on the type of headrail and vane size. Refer to the chart below for depth requirements.

Depth Chart for Bracket Placement		
Headrail Type	Minimum	Fully Recessed
Classic	1"	3 ⁵ / ₁₆ "
Quartette® 4"	1"	3 ¹³ / ₁₆ "

Note: Add 1/4" to the minimum depth dimensions if the optional back cover is used for inside mounts.

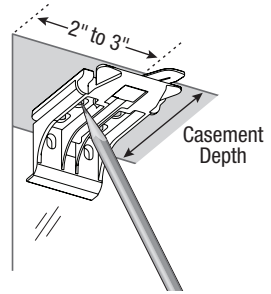

- Use a level to check that the mounting surface is level. Shim the brackets, if necessary (use the top tab that was removed from the brackets).
- Drill the screw holes using a 3/32" drill bit.

CAUTION: Use drywall anchors when mounting into drywall.

- Attach the installation brackets using the screws provided.

IMPORTANT: Do not overtighten the screws. Check to ensure the lever can be moved easily side to side. If not, loosen the screws in one-eighth turn increments until the lever can be moved easily.

IMPORTANT: The front edges of the installation brackets must be level and aligned to each other.

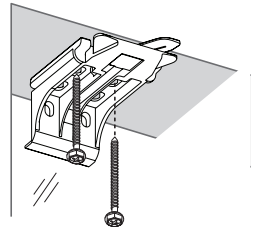

- **If using the optional back cover:** Install the cover into the back cover brackets. If necessary, trim the back cover to the desired width.

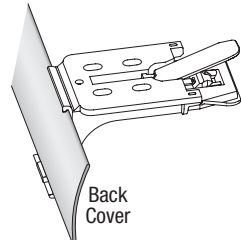

Proceed to "Install the Shading" on page 9.

INSTALLATION

Mount the Installation Brackets — Outside Mount

Prepare the Installation Brackets

- Use pliers or heavy duty scissors to remove both the top and bottom tabs on the installation brackets.

NOTE: Save these tabs once removed. They may be used as shims, if necessary.

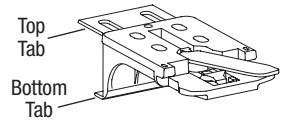

Mount the Installation Brackets

- Center the headrail over the window opening at the desired height. Use a pencil to lightly mark each end of the headrail.
 - Alternatively, measure the width of the headrail and use that width to mark the headrail end points over the window opening.
- Mark 2" to 3" from each end of the headrail.
 - If more than two installation brackets came with your order, space additional bracket(s) evenly between the two end brackets and mark their location. Mount into wood whenever possible.

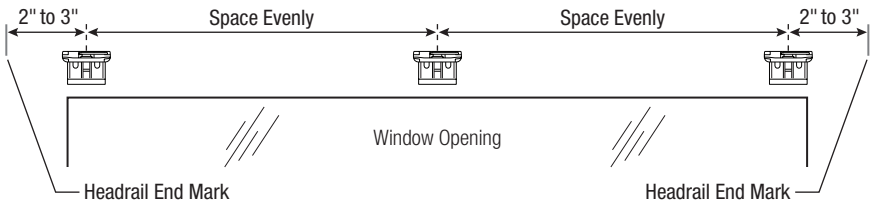

- **Two-On-One Headrail Shadings.** Place the installation brackets as shown in the illustration below.

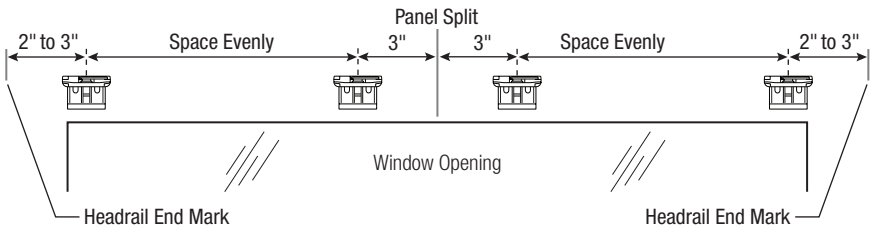

- Center the installation brackets or extension brackets on your marks and mark where to drill the screw holes.
- A minimum 1 1/8" flat vertical surface is required for the installation brackets. Extension brackets require 1 1/4".
- The tops of the installation brackets or extension brackets should be at the desired height. The brackets should be level and aligned.

CAUTION: The rear of the brackets must be flush against a flat mounting surface. Do not mount brackets on curved molding.

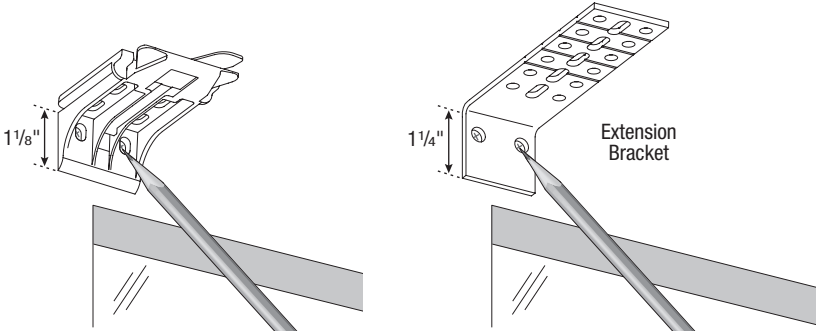

- Drill the screw holes using a 3/32" drill bit.

CAUTION: Use drywall anchors when mounting into drywall.

- Attach the installation or extension brackets using the screws provided.

IMPORTANT: The tops of the installation brackets or extension brackets must be level with their front edges aligned.

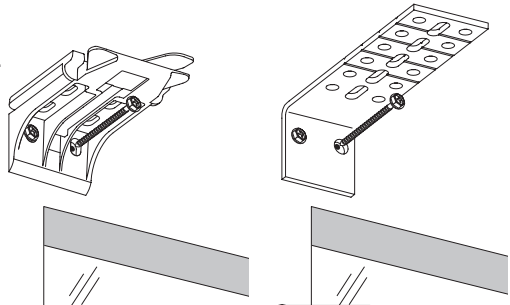

- If using spacer blocks, attach the spacer block(s) and installation bracket to a flat vertical mounting surface with #6 screws long enough for a secure installation.

IMPORTANT: Do not add more than 1 1/2" of clearance using spacer blocks.

IMPORTANT: The tops of the installation brackets must be level with the front edges aligned.

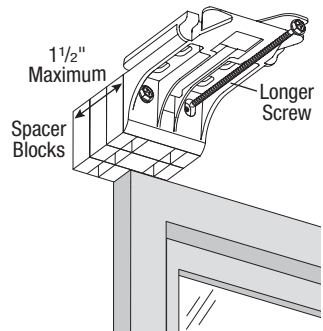

INSTALLATION

- If using extension brackets, attach an installation bracket to the underside of each extension bracket using the speed nuts and screws provided.

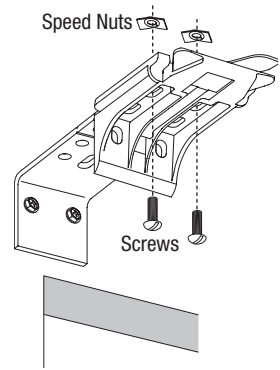

Proceed to “Install the Shading” on page 9.

Mount the Installation Brackets — End Mount

End mount the headrail when conventional mounting techniques will not work — for example, in an arched window opening.

- Mount the extension brackets on a flat vertical surface at least 1 1/4" wide.
 - Add 1/4" to the minimum depth if using the optional back cover.
- Attach the installation brackets to the extension brackets using the provided screws and speed nuts.

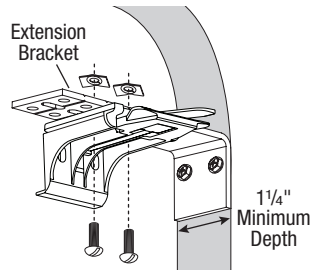

WARNING: To end mount shadings into a surface other than a secure wall stud, use medium to heavy-duty wall anchors (not provided) matched to the wall thickness. Failure to mount the brackets securely may result in injury or property damage.

- **If using the optional back cover:** Install the cover into the back cover brackets. If necessary, trim the back cover to the desired width.

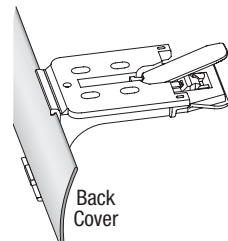

Proceed to “Install the Shading” on page 9.

Install the Shading

- Peel back the protective covering from the top of the fabric-covered headrail. Leave the rest of the protective covering on the front of the headrail.

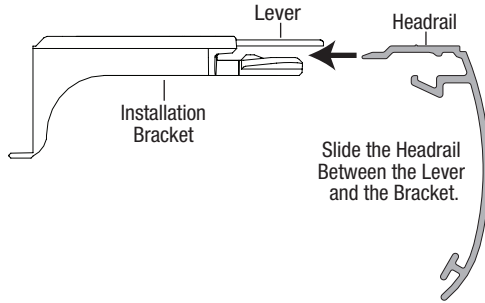

- Position the shading so that the front faces you.
- Slide the headrail into the installation brackets so the edge of the headrail is between the lever and the bracket, as shown.
- Firmly push the headrail into each bracket until it clicks and the lever snaps to the right side of the bracket.

IMPORTANT: Carefully pull on the headrail at each bracket to ensure it is installed securely.

- Completely remove the protective covering from the fabric-covered headrail.

Attach the Universal Cord Tensioner (UCT) for EasyRise™ Only

IMPORTANT: Before you proceed, you must first slide the cord tensioner to the bottom of the cord loop.

- Insert a small screwdriver, punch, or awl through the screw hole at the bottom of the cord tensioner.
- Move the screw hole down to the indicator line to release the safety mechanism.
- Slide the cord tensioner down to the bottom of the cord loop.
- Attach the cord tensioner according to the instructions provided with the *Universal Cord Tensioner Installation Kit*.

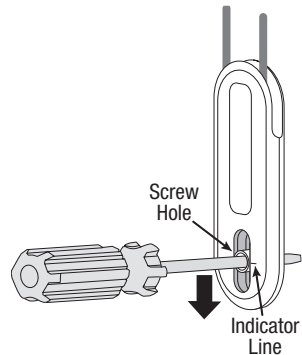

WARNING: It is imperative that the cord tensioner be properly secured to the wall or window frame to reduce children's access to the cord loop. Young children can strangle in cord loops. They can also wrap cords around their necks and strangle.

CAUTION: The shading will not operate properly unless the cord tensioner is secured. A Universal Cord Tensioner Installation Kit has been included with your shading. Follow the instructions in the kit to correctly secure the cord tensioner.

Final Adjustments

Adjust the Cord Length for UltraGlide® 2 Click and Walk Away™ System Only

Adjusting the tassel to eye level will decrease the amount of pulls needed to raise and lower the shading. This will also enhance child safety.

To Shorten the Tassel Cord

- Grasp both parts of the tassel (the colored cover and the frosted body).
- Squeeze the tassel cover with your thumb and forefinger (at the “s” of the Hunter Douglas logo).
- Separate and slide the tassel cover from the tassel body.
- Pull out the knotted end of the tassel cord.
- Retie the cord at the desired shorter length, using a double knot.
- Trim the tassel cord.
- Pull the trimmed knot up inside the tassel.
- Squeeze the sides of the tassel cover together while sliding it back onto the tassel body.

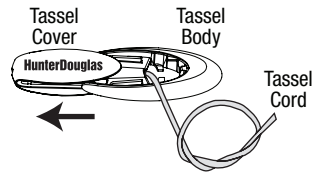
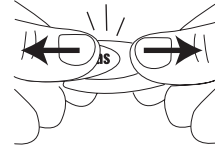

IMPORTANT: After reassembling, be sure there are no gaps between the two components. Check that they do not pull apart easily. The tassel cover should be securely seated into the tassel body.

Attach the Magnetic Hold-Down Brackets (Optional)

- Lower the shading, keeping the vanes closed.
- Place the magnetic hold-down bracket onto the bottom rail just inside the end cap, oriented as shown.
- Hold the bracket while opening and closing the vanes. (It may be necessary to have someone assist you.) Adjust the bracket to the best overall position.
- Mark the screw location using the mounting options shown below.
 - The screw should be placed in the middle of the channel. This will allow for adjustment.

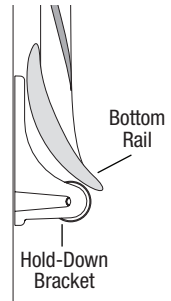

Outside Mount



Preferred



Alternate

Inside Mount



Preferred



Alternate

- Drill the screw holes using a $\frac{3}{32}$ " drill bit.

IMPORTANT: Use drywall anchors when mounting into drywall.

- Attach the hold-down brackets to the mounting surface using the screws provided.
- If necessary, adjust bracket height by loosening the screw and sliding the bracket up or down.

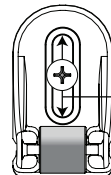

Adjust bracket height by loosening the screw and sliding the bracket up or down.

INSTALLATION

Attach the Dust Cover (Optional for Outside Mounts and End Mounts)

The dust cover is used to protect the top of the headrail from exposure on outside mounted shadings.

- Cut the dust cover to desired width.
- Remove the paper backing on one side of the hook and loop fastener dots.
- Apply the dots to the installation brackets on each end of the shading.



Overhead View
No Dust Cover

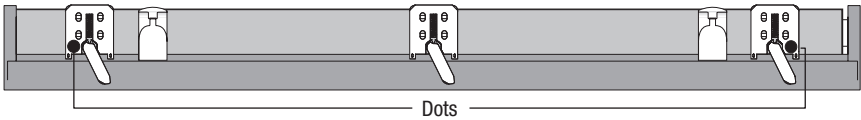

- Remove the remaining paper backing from the dots.
- Center the dust cover over the top of the shading, above the dots.
- Press the dust cover down onto the dots.

Dust Cover Installed

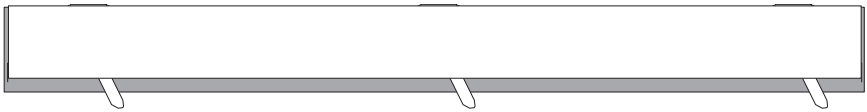

Install the Pull Tassel (Optional for LiteRise® Only)

- Rotate the bottom rail so that you can see the underside of the handle.
- Push the pull cord loop through the hole at the back of the handle.
- Thread the pull tassel through the loop.
- Pull the tassel to secure.

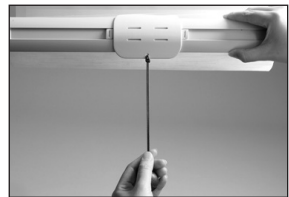
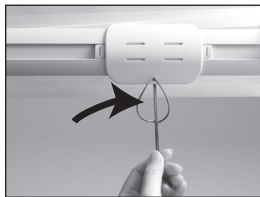

Operate the Shading

EasyRise™ Shadings

To Lower the Shading and Open the Vanes

- Pull the rear cord of the cord loop down to lower the shading.
- With the shading fully lowered, continue to pull the rear cord to tilt the bottom rail and open the vanes.
- If the cord tensioner moves up the cord, you have not secured it to the wall or window frame. You must do so for the shading to operate properly.

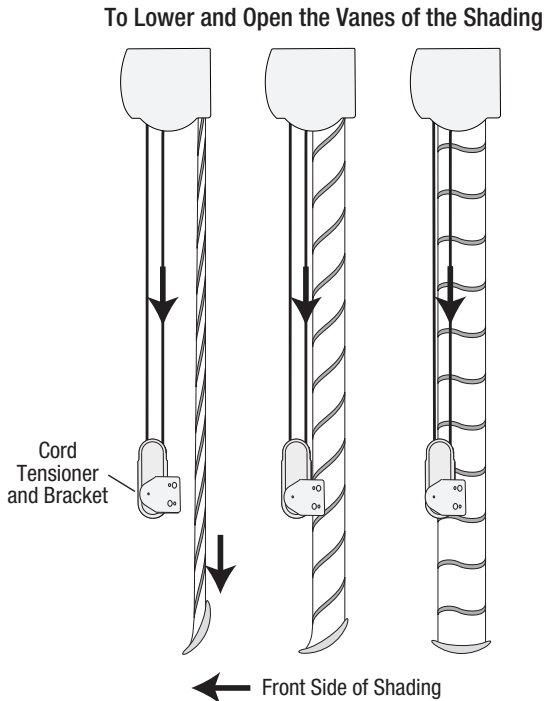

To Close the Vanes and Raise the Shading

- Pull the front cord of the cord loop down to close the vanes and raise the shading.
- If the cord tensioner moves up the cord, you have not secured it to the wall or window frame. You must do so for the shading to operate properly.

IMPORTANT: If the shading raises or lowers unevenly, the fabric rubs against one end of the headrail, or the bottom rail is uneven when fully raised, the bottom rail weight needs to be adjusted. See “Adjusting the Bottom Rail Weight” on page 18.

To Close Vanes and Raise the Shading

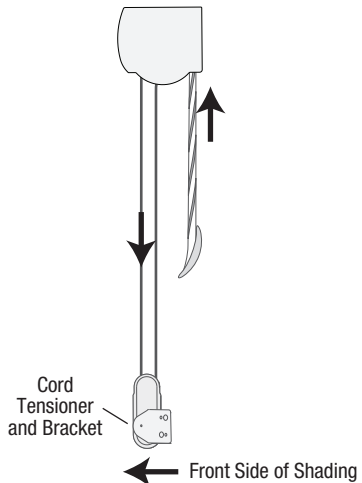

OPERATION

UltraGlide® 2 Click and Walk Away™ Shadings

To Lower the Shading and Open the Vanes

- Pull the cord toward the center of the shading. Listen for a “click” and then release the cord.
- The vanes automatically open once the shading is completely lowered.
- The shading can be stopped at any point while lowering by slightly tugging the cord straight down.

Lower
and Open
Vanes by
Pulling to
Center

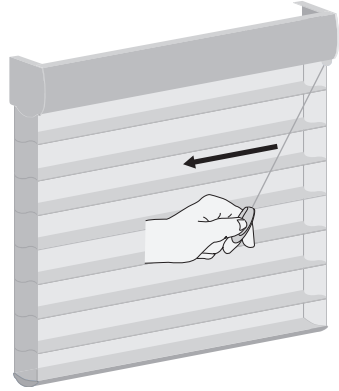

To Tilt the Vanes and Raise the Shading

- Pull the cord straight down with long strokes.
 - Pull the cord with shorter strokes to tilt the vanes.
- With each stroke the vanes close or the shading partially raises.
- Allow the cord to retract completely into the headrail after each downward stroke.
- Use multiple strokes until the shading reaches the desired position.
- The shading can be stopped at any point while raising.

Tilt
Vanes and
Raise by
Pulling
Straight
Down

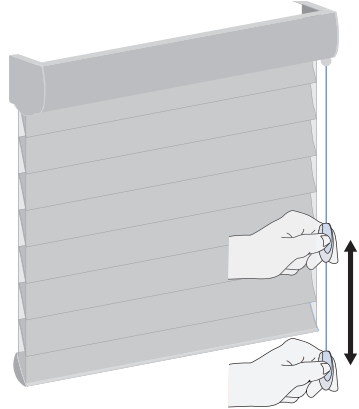

LiteRise® Shadings

To Lower

- Slowly and steadily pull down on the bottom rail handle to lower.



To Open

- With your thumb on the front of the handle and fingers on the back, gently pull the back of handle down and away from the shading to open the vanes.
- Use the handle to tilt the vanes to the desired open/closed position.



To Raise

- Push down on the front of the handle to close the vanes. Then slowly and steadily push up on the handle to raise.



Troubleshooting

Problem	The shading will not snap into the installation brackets.
Solution	Check that the installation brackets are aligned and level. Check that the locking tab on the installation bracket slides over the headrail.
Problem	The shading is hard to raise or lower, or will not raise or lower.
Solution	<p>Shadings cannot be forced into tight inside mount window openings. If an inside mount, make sure there is clearance between the ends of the shading and the window casement.</p> <p>For LiteRise® only: If the vanes are open, be sure to close the vanes first by pressing down on the front of the handle. If necessary, pull the shading away from the window to fully close. Once the vanes are closed you can raise the shading.</p> <p>For EasyRise™ only: Check that the universal cord tensioner is mounted correctly.</p> <ul style="list-style-type: none">■ Pull down on the spring to relieve tension and pull the universal cord tensioner to the bottom of the cord loop. Properly mount the cord tensioner. See the <i>Universal Cord Tensioner Installation Instructions</i> included with your shading. <p>Check that the installation brackets are level. Shim to level, if necessary.</p>
Problem	EasyRise shadings only: The universal cord tensioner has climbed to the headrail.
Solution	Pull down on the spring to relieve tension and pull the universal cord tensioner to the bottom of the cord loop. Properly mount the cord tensioner. See the <i>Universal Cord Tensioner Installation Instructions</i> included with your shading.
Problem	EasyRise shadings only: The universal cord tensioner grabs onto the cord upon operation.
Solution	Check that the universal cord tensioner is mounted properly. Reinstall, if necessary.

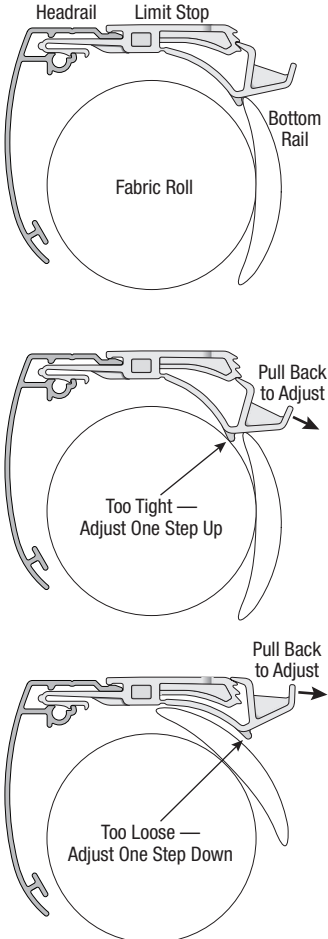
<p>Problem</p>	<p>The shading is hard to raise or lower, or the bottom rail does not stop at the top limit.</p>
<p>Solution</p>	<p>Check the adjustment position of both limit stops. The top illustration shows the correct adjustment. The limit stop catches the bottom rail, and the bottom of the limit stop is slightly above or barely touching the fabric roll.</p> <p>In the second illustration, the limit stop adjustment is too tight. The fabric may not drop freely and could even be damaged when the shading is raised. To correct this, the limit stop should be adjusted one step up. Simply pull back on the rear of the limit stop to adjust its position.</p> <p>In the bottom illustration, the adjustment is too loose. The bottom rail can slip under the limit stop. If the bottom rail rotates through the headrail, it must be backed out before adjusting the limit stop.</p> <p>IMPORTANT: Both limit stops must be adjusted to the same position or else skewing may occur.</p> <div style="text-align: right;">  </div>
<p>Problem</p>	<p>The shading raises or lowers unevenly or the bottom rail is uneven when fully raised.</p>
<p>Solution</p>	<p>Check that the window is square by measuring the diagonals.</p> <p>Check that the installation brackets are level. Shim to level, if necessary.</p> <p>Adjust the bottom rail weight (not applicable for LiteRise® shadings). See next page.</p> <p>For LiteRise Only: Keep the bottom rail level while raising the shading. Side-to-side movement while raising may cause the fabric to skew.</p>

OPERATION

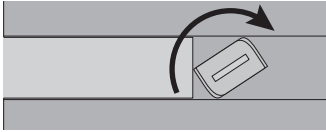
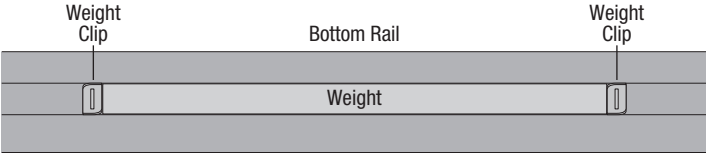
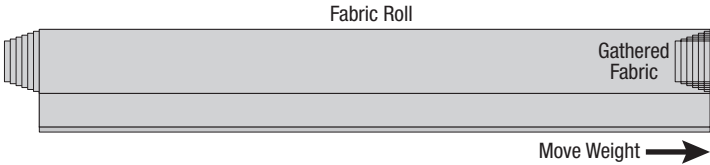
<p>Problem</p>	<p>The shading raises or lowers unevenly, the fabric rubs against one end of the headrail, or the bottom rail is uneven when fully raised.</p>
<p>Solution</p>	<p>Check that the window is square by measuring the diagonals.</p> <p>Check that the installation brackets are level. Shim to level, if necessary.</p> <p>Adjust the bottom rail weight. See below.</p> <p>Adjusting the Bottom Rail Weight</p> <ul style="list-style-type: none"> ■ Release the weight clips by inserting a flat blade screwdriver into the weight clip and turning clockwise.   <ul style="list-style-type: none"> ■ Move the weight in 1" increments toward the side where the fabric is gathering.  <ul style="list-style-type: none"> ■ Secure the weight clips in position by turning them counterclockwise after making the adjustment. ■ Test and, if necessary, adjust again.
<p>Problem</p>	<p>Vanes do not align on side-by-side shadings.</p>
<p>Solution</p>	<p>Vane alignment is only guaranteed within 1/4" when shadings are ordered at the same time, at the same height, with the same color and fabric, and when specified on the order form.</p> <p>Check that the windows are square and the same height.</p>

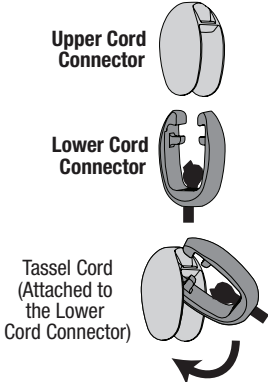
Problem.	LiteRise® shadings only: Vanes will not open.
Solution	With your thumb on the front of the handle and fingers on the back, gently pull the back of handle down and away from the shading to open. The shading must be fully lowered to tilt it open.
Problem	UltraGlide® 2 Click and Walk Away™ Shadings Only: The tassel cord and lower cord connector have detached from the upper cord connector.
Solution	<p>To Reattach the Tassel Cord:</p> <ul style="list-style-type: none"> ■ Hook one side of the lower cord connector to the upper cord connector. ■ Rotate the lower cord connector until it snaps into place. ■ Twirl the tassel cord to pull any stray cord fibers out of the junction of the cord connector halves. Stray fibers in the junction may cause the connector to come apart. <div style="text-align: right;">  </div>
Problem	Two-On-One Headrail Shadings Only: The center gap is not even from the top to the bottom of the shading, interfering with the function of the shading.
Solution	Ensure the entire length of the headrail is straight and level. If the center portion of the headrail is higher than the ends, the center gap will close together. If the center portion of the headrail is lower than the ends, the center gap increases. If necessary, adjust the height of each bracket by moving it within the screw slots or by using shims.

CARE

Removing the Shading

- Move each lever of the installation brackets to the left to release the shading.

➤ A flat blade screwdriver can be used to move the lever.

CAUTION: Be very careful not to tear or damage the fabric.

➤ If the lever is inaccessible or inoperable, lower the shading until you can see the underside of the bracket. Carefully reach a small flat blade screwdriver behind the shading to the tab on bottom of the bracket between the screw holes.

➤ Push the tab away from the shading and pull the headrail to release it from the bracket.

- Carefully pull the shading to remove it from the brackets.

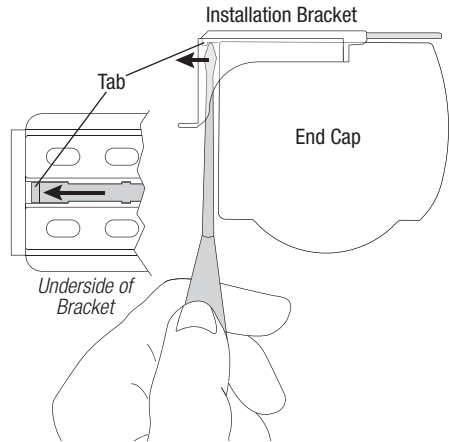
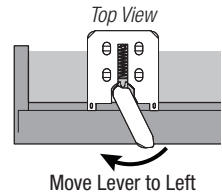

Cleaning Procedures

Silhouette® and Nantucket™ window shadings are made of 100% polyester, which means they are inherently durable and resilient. However, care must be taken to avoid wrinkling the fabric, particularly where the vanes meet the facings.

The Palette® Fabric-Covered Headrail

- Spot-clean the headrail using a sponge or delicate cloth, cool distilled water and a mild soap solution; handle with care as you would any fine fabric.

Dusting

- Regular light dusting with a feather duster is all the cleaning needed in most circumstances.

Vacuuming

- Use hand-held vacuum with low suction, for more thorough dust removal.

Forced Air

- Blow away dirt and debris between the vanes using clean compressed air.

Spot-Cleaning

- Do not spot-clean anything other than the Palette® Fabric-Covered Headrail on Silhouette® or Nantucket™ window shadings.

Ultrasonic Cleaning

Silhouette and Nantucket window shadings can be ultrasonically cleaned by a professional, **with the exception of Boardwalk™, Bon Soir™, Chateau™, East Bay™, Misty Harbor™, The Alustra® Collection (excluding French Linen), The Matisse Collection®, The Matisse Collection Bon Soir, Très Vue™, and Sun Porch™ fabrics.**

- Specify that a mild detergent solution be used.
- Never immerse the headrail in the solution.
- Dry the shading completely in the lowered position.

Injection/Extraction

Silhouette and Nantucket window shadings can be professionally cleaned using the injection/extraction method.

- Use only the dry method of injection/extraction for Bon Soir, Brio™ Bon Soir, French Linen Bon Soir, Misty Harbor, and The Matisse Collection Bon Soir.
- Never immerse the headrail in the solution.

Electrostatic Cleaning

Do not use electrostatic cleaning wipes on any Silhouette or Nantucket window shadings.

A Note About Hardware for The Alustra Collection

Gold Radiance™, Silver Reflection™, Bronze Shimmer™, and Champagne Shine™ hardware finishes can be spot-cleaned with luke warm water and a gentle soap. Do not use alcohol, baby wipes or alkaline cleansers. These may stain or destroy the finish.

A Note About Silhouette and Nantucket Fabrics

As with all textiles, Silhouette and Nantucket fabrics are subject to some variations. Slight wrinkling, puckering, or bowing is inherent to this textile product and should be considered normal, acceptable quality. These characteristics are not usually visible from the front or rear but may be visible from a side angle.

Precautions should be taken to reduce exposure to harsh environmental elements, such as salt air. Continuous exposure through open windows and doors will accelerate the fabric deterioration.



WARNING

For more safety information call 1-888-501-8364 in the U.S. or 1-866-662-0666 in Canada.

- Young children can STRANGLE in cord loops. They can also wrap cords around their necks and STRANGLE.
- Always keep cords out of the reach of children.
- Move cribs, playpens and other furniture away from cords. Children can climb furniture to get to cords.

Cord Loop Shadings

- Attach the cord tensioner on the cord loop to the wall or window casement. See *Attach the Universal Cord Tensioner (UCT)* on page 9. This can prevent children from pulling cord loops around their necks.
- Hunter Douglas provides a cord tensioner installation kit with instructions for attaching the cord tensioner. For the shading to operate properly, the cord tensioner must be correctly mounted and secured.
- Fasteners provided in this kit may not be appropriate for all mounting surfaces. Use appropriate anchors for the mounting surface conditions.
- Only Hunter Douglas supplied cord tensioners and hardware should be used. Replacement parts may be obtained by contacting the Hunter Douglas Customer Information Center at 1-888-501-8364.

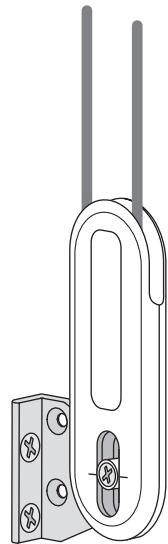

NOTE: The warning labels on the bottom rails of corded window coverings contain important safety information. These warning labels are designed to be permanent, in accordance with the industry's safety standards, and must not be removed.