

# CE60 1" Aluminum Horizontal Blinds



Ideal for larger installations, our Model CE aluminum blinds feature our sturdiest headrail for 1" blinds. Model CE60 provides superior light control with 20mm tape spacing and resilient 1" x .006" slats.

## KEY FEATURES

- 1" x 1 1/2" x .024" Headrail
- Heat-treated, spring-tempered aluminum slats
- Clutch tilter prevents over-rotation of slats
- Closed oval steel bottom rail provides optimal strength to prevent bowing
- Slats contain 95% recycled aluminum content and are GREENGUARD GOLD Indoor Air Quality Certified®
- Cord stop to single cord pull
- Lifetime Guarantee

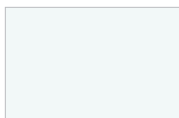

885 Flex White

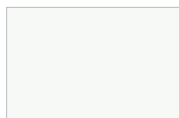

110 Gloss White



001 Glacier White

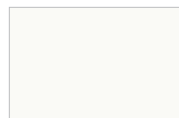

127 Linen Flirt

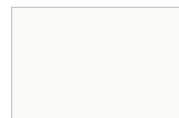

974 Pearl

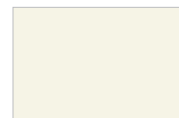

002 Alabaster

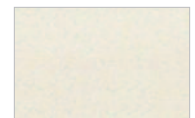

830 Almond

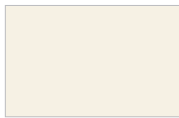

973 Antique White



268 Crème de la Crème

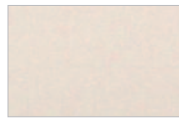

269 Chenille

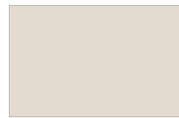

205 Fawn

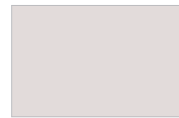

795 Surf



748 Shadow Gray



065 Brushed Aluminum



064 Bronze

**HunterDouglas**   
Architectural

© Copyright Hunter Douglas Contract 2016

® Hunter Douglas and its product names are registered trademarks

® The GREENGUARD GOLD INDOOR AIR QUALITY CERTIFIED mark is a registered certification mark used under license through the GREENGUARD Environmental Institute.

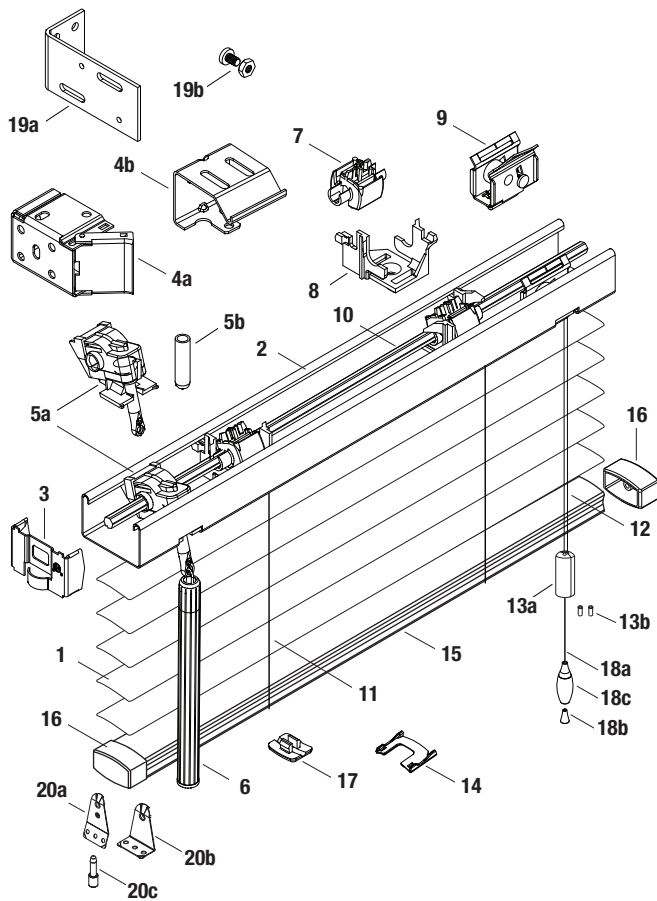

**STANDARD COMPONENTS:**

1. Slat
2. Headrail
3. End Lock
- 4a. Box Installation Bracket
- 4b. Intermediate Support Bracket
- 5a. Wand Tilter
- 5b. Tilter Protector
6. Wand
7. Tape Roll
8. Tape Roll Support
9. Cordlock Assembly
10. Tilt Rod
11. Cable Tape Ladder
12. Lift Cord 1.4mm
- 13a. Cord Stop
- 13b. Safety Tassel Grommet
14. Tape Spacer
15. Bottom Rail
16. Bottom Rail End Cap
17. Tape Button
- 18a. Lift Cord
- 18b. Conical Tassel Washer
- 18c. Tassel

**OPTIONAL COMPONENTS:**

- 19a. Extension Bracket
- 19b. Extension Bracket Screw and Nut
- 20a. Hold-Down Bracket (Jamb)
- 20b. Hold-Down Bracket (Sill)
- 20c. Hold-Down Pin

## PRODUCT SPECIFICATIONS

### PART 2 – PRODUCTS

#### 2.01 ACCEPTABLE MANUFACTURER

- A. Hunter Douglas Architectural / 13915 Danielson St., Ste.100/ Poway, CA 92064 / Phone: 800-727-8953 / Fax: 800-205-9819 / Website: HDarchitectural.com or architect approved equivalent.
- B. Product substitutions must be approved by architect minimum of 30 days prior to close of bid.

#### 2.02 1" MINI HORIZONTAL ALUMINUM BLINDS

- A. **PRODUCT:** Hunter Douglas "CE60 1" Aluminum Blind"

#### B. MATERIALS:

1. **SLATS:** 1" wide x .006" thick, heat-treated and spring tempered (except 5000 series alloy on metallized finishes) aluminum alloy 6011 with eased corners and manufacturing burrs removed. Product to have a minimum of 95% pre-consumer recycled content. Furnish not less than nominal 15.2 slats per foot to ensure tight closure and light control. Finish with manufacturer's standard baked-on finish in colors selected by architect from manufacturer's available contract colors utilizing Dust Shield™ finish to inhibit dust build-up for easier maintenance.
2. **SLAT SUPPORT:** Braided ladders of 100% polyester yarn color compatible with slats and spacing of ladder no more than 20mm.
3. **HEADRAIL:** U-shaped profile with rolled edges, measuring 1" x 1 1/2" x .024" constructed of corrosion resistant steel. Internally fit with components required for specified performance and designed for smooth, quiet, trouble-free operation. Headrail finish to be standard baked-on polyester and to match slats. Ends fitted with .030" steel end lock with adjustable tab for centering blinds.
4. **BOTTOM RAIL:** Steel, with corrosion-resistant finish formed with double-lock seam into closed oval shape for optimum beam and torsional strength. Ends fitted with color-coordinated engineered polymer caps. Color-coordinated engineered polymer tape buttons secure the ladder and cord. Bottom Rail finish to be standard baked-on polyester color coordinated to slats.

5. **LIFTING MECHANISM:** Crashproof steel cordlocks with corrosion-resistant finish, two-ply polyester cord filler in braided polyester jacket lift cords, cord equalizers, cordlock adapter, and Cord Stop/Single Pull Cord. Located on either side of individual blind unit as per architect's request.
6. **TILTING MECHANISM:** Permanently lubricated die-cast worm and gear type tilter gear mechanism in fully enclosed housing with clutch action to protect ladder tapes from over rotation of the solid steel, corrosion resistant tilt rod.
7. **TILT CONTROL WAND:** Tubular shaped 7/16" diameter extruded clear plastic, ribbed for positive grip and detachable without tools. Located on either side of individual blind unit as per architect's request.
8. **MOUNTING HARDWARE:** Manufacturer's standard .042" steel box brackets with baked-on polyester finish to match headrail with additional support brackets for blinds over 60" wide.
9. **ADDITIONAL AVAILABLE OPTIONS:** Limited Tilt, Pivot Plates, Two-Position Cord Locks, Color Striping, 2 or 3 Blinds on 1 Headrail, Valances, Side Channels (limited colors available), Hold Down Brackets, Cutouts.

#### 2.03 FABRICATION

- A. Blind measurements shall be accurate to within + 1/8" or as recommended in writing by manufacturer.

#### 2.04 FINISHES

- A. **SLAT** finish selection from the following: 001 Glacier White, 002 Alabaster, 064 Bronze, 065 Brushed Aluminum, 110 Gloss White, 127 Linen Flirt, 205 Fawn, 268 Crème de la Crème, 269 Chenille, 270 Linen, 748 Shadow Gray, 795 Surf, 830 Almond, 885 Flex White, 973 Antique White, 974 Pearl.
- B. **SLAT SUPPORT** braided ladders shall be color coordinated with slat.