

# Duette® FR Honeycomb Shades



The durable, energy-efficient design of Duette® FR Honeycomb Shades makes them an ideal choice for healthcare and assisted living centers, government/military buildings, and a wide range of public spaces.

## KEY FEATURES

- GREENGUARD GOLD certified for low-emitting products
- Fabrics meet all requirements of NFPA 701 small scale flammability testing for commercial applications
- Energy-efficient honeycomb design
- Fabric covered headrail standard with EasyRise™
- Lifetime Guarantee



## Fabrics: 3/4" Opaque (D23)

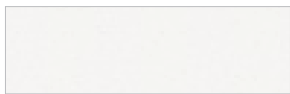

951 Daisy White

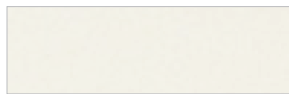

457 Journal

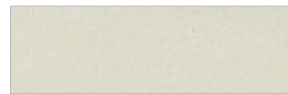

682 Platinum

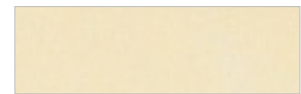

989 Bisque

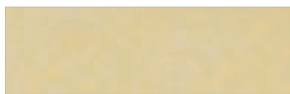

687 Toasted Almond



695 Autumn Harvest

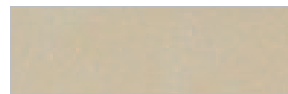

686 Truffle

## Fabrics: 3/4" Semi-Opaque (D22)

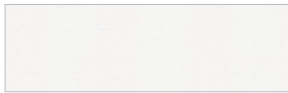

951 Daisy White



457 Journal



907 Beach Shells



989 Bisque

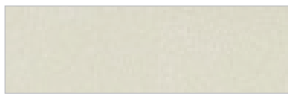

682 Platinum



713 Pearl Gray



733 Patina Gray



687 Toasted Almond



695 Autumn Harvest

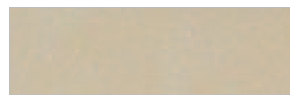

686 Truffle



750 Graphite



749 Black Onyx

**HunterDouglas**   
Architectural

© Copyright Hunter Douglas Contract 2021

© Hunter Douglas and its product names are registered trademarks

© The GREENGUARD GOLD INDOOR AIR QUALITY CERTIFIED mark is a registered certification mark used under license through the GREENGUARD Environmental Institute.

No.	PCN	Description
1.	2780229002	Headrail Light Block Strip
2.		Headrail
3.		Headrail End Cap
		<b>See Honeycomb Headrails</b>
4.		Clutch Cover
		<b>See Honeycomb Headrail End Caps</b>
5.	2801669000	Cord Sprocket
6.		Clutch Assembly
	2802573000	3/8" & 3/4", RH
	2802574000	3/8" & 3/4", LH
	1002512	1 1/4", RH
	1002513	1 1/4", LH
7.	2910001000	Screw
8.	2780115000	Gearbox
9.	2770004000	V.Shaft (steel)
10.	2780128000	Lock Collar w/Set Screw
11.	2780135000	Drop Stop Housing
12.	2780120000	Drop Stop Assembly, RH
13.		Spool
	2780034000	Standard
	2780103000	Long Drop
14.		Spool Support
	2780033000	Standard
	2780105000	Long Drop
15.	1003020	0.9 mm Cord, White
16.		Bottom Rail
		<b>See Honeycomb Bottom Rails</b>
17.		Bottom Rail End Cap
		<b>See Honeycomb Bottom Rail End Caps</b>
18.	2780923000	EasyAdjust™ Pocket Cover (4000/ carton)
19.		EasyAdjust Assembly
	2801404000	3/8", 3/4"
	2781318000	1 1/4"
20.		Cord Loop
		<b>See EasyRise Cord Loops</b>
21.		Universal Cord Tensioner (UCT)
		<b>See Universal Cord Tensioners</b>
22.		Filler Strip
	2954000000	3/8"
	1000132	3/4"
	2971311000	1 1/4"
23.	N/A	Fabric
		<b>Shades with AOS</b>
24.	2970035000	3/4" Magnet Strip with Foam (Only for orders with AOS)
		<b>Shades with Hold-Down Magnets</b>
25.	KIT2777	Hold-Down Magnet Assembly
26.	2981043000	Spring Holder Pivot Lock
		<b>OB Shades Only</b>
27.	2780228000	ER Fabric Stop

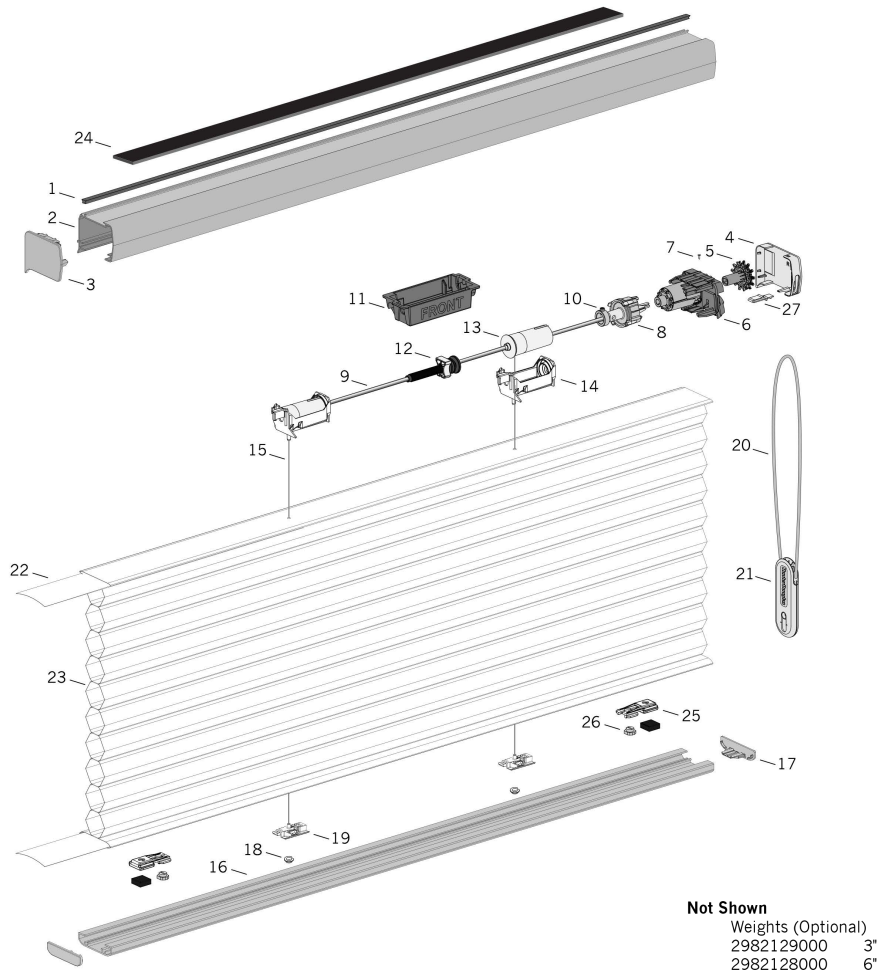

**Not Shown**  
 Weights (Optional)  
 2982129000 3"  
 2982128000 6"

XXX = 3-digit color code

## PRODUCT SPECIFICATIONS

### PART 2 – PRODUCTS

#### 2.01 ACCEPTABLE MANUFACTURER

- A. Hunter Douglas Architectural / 13915 Danielson St., Ste.100/ Poway, CA 92064 / Phone: 800-727-8953 / Fax: 800-205-9819 / Website: HDarchitectural.com or architect approved equivalent.
- B. Product substitutions must be approved by architect minimum of 30 days prior to close of bid.

#### 2.02 COMMERCIAL HONEYCOMB SHADES

- A. **PRODUCT:** Hunter Douglas “Duette® FR Honeycomb Shades”

#### B. MATERIALS:

1. **FABRIC:** Permanent flame-resistant textured, non-woven polyester formed into opaque 3/4" hexagonal honeycomb cells in stacked tubular construction. Single cell construction; with each cell an independent piece of fabric and containing a metal-lized polyester film core. Finish selected by architect from manufacturer's available contract colors.
2. **HEAD/BOTTOM RAIL:** Standard 3/4" fabric type measuring 1.875" x .460" x .040" thick, EasyRise™ 2" x 1.875" x .050" thick headrail with bottom rail measuring 1.875" x .460" x .469" thick. Constructed of aluminum alloy 6063. Internally fit with components required for specified performance and designed for smooth, quiet, trouble-free operation. Finish to be standard polyester based paint with a fabric-covered valance to coordinate with fabric (EasyRise™ headrail white finish, bottom rail to coordinate with fabric). Ends fitted with polycarbonate end caps color coordinated with fabric (EasyRise™ headrail end caps white, bottom rail end caps color-coordinated to sill rail).

3. **LIFTING MECHANISM:** Molded engineering plastic cordlock color-coordinated to fabric with stainless steel components providing durable and crash-proof operation (EasyRise™ white engineered plastic rotary clutch mechanism provides ease of operation when continuous cord loop is activated and holds shade in place unless force is applied). Color coordinated braided polyester .035" lift cord and .086" tassel cord, tassel, and stop-ball (EasyRise™ color-coordinated braided polyester .11" continuous cord loop provides uniform cord length with polycarbonate cored tensioner for additional safety. White nylon covered polyester 2.45mm wide x 0.17mm thick lift tape allows for easy operation of heavy shades). Located on either side of individual shade unit as per architect's request.
4. **MOUNTING HARDWARE:** Manufacturer's standard polycarbonate universal hidden brackets (EasyRise™ nylon coated zinc-plated 1040 steel HR steel), provide a sleek, unobtrusive appearance.
5. **ADDITIONAL AVAILABLE OPTIONS:** Top-Down, Top-Down/Bottom-Up, 2 Blinds on 1 Headrail, Specialty Shapes, Skylight System, Hold Down Brackets, Motorization (EasyRise™: Hold Down Brackets, Motorization)

#### 2.03 FABRICATION

- A. Blind measurements shall be accurate to within + 1/8" or as recommended in writing by manufacturer.

#### 2.04 FINISHES

- A. **FABRIC** finish to be duotone with neutral tone facing the exterior and color selection facing the interior. Color selection from the following: Opaque (D23): 951 Daisy White, 457 Journal, 989 Bisque, 687 Toasted Almond, 695 Autumn Harvest, 686 Truffle. Semi-Opaque (D22): 951 Daisy White, 457 Journal, 907 Beach Shells, 989 Bisque, 682 Platinum, 713 Pearl Gray, 733 Patina Gray, 687 Toasted Almond, 695 Autumn Harvest, 686 Truffle, 750 Graphite, 749 Black Onyx.