



IGC 4N1
MOTOR CONTROLLER RTS
RECEIVER APPLICATION

-  AC POWER 3-WIRE
-  DRY CONTACT KEYPAD CONNECTION VIA CAT5e
-  14/4 Wire 120V FROM EACH MOTOR TO 4N1



Set your dip switches to desired configuration. See IGC 4N1 MOTOR CONTROLLER instructions for further details

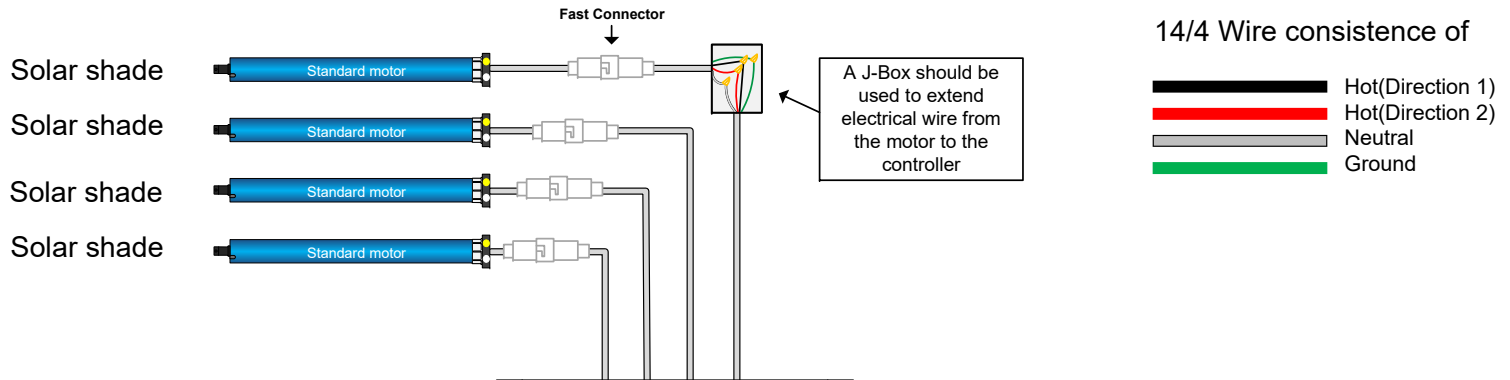
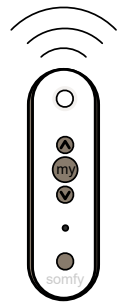
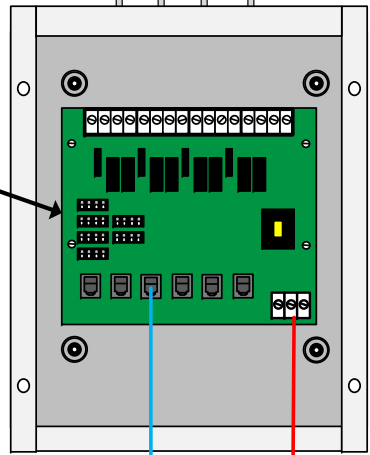
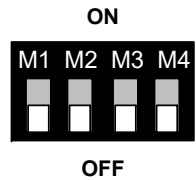

TELIS 1CH REMOTE



AC power input