



Installation Instructions

RB 500 Manual Roller Shades

Heavy Duty Clutch Coupled Fascia

5-237 Series-Coupled Unit

WARNING/ADVERTENCIA



Window Blind Cord Strangulation Risk

Window blinds with a damaged or loose tension device or retractable cord that fails to fully retract pose a strangulation risk to children. To avoid this potential strangulation risk, consider purchasing cordless products or products with inaccessible cords.

Riesgo de Estrangulamiento en Cuerdas de Persianas

Las persianas con un dispositivo tensor suelto o dañado o con una cuerda retráctable que no se ajusta completamente representan un riesgo de estrangulación para los niños. Para evitar un posible riesgo de estrangulamiento, considere comprar productos inalámbricos o productos con cuerdas inaccesibles.



Installation

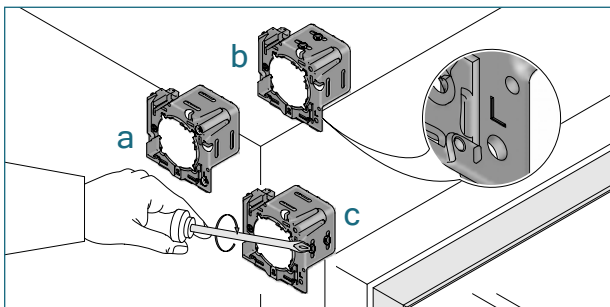

Install the clutch bracket and intermediate bracket first.

a) recess b) ceiling c) wall

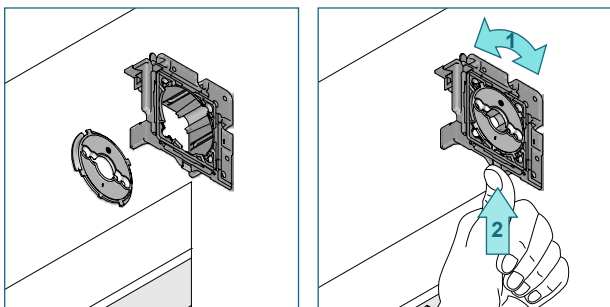

Insert the Plate L into the intermediate bracket. Turn the Plate L in the rolling off direction (1) and secure with the locking clip (2).

Not necessary when using bracket with leveler.

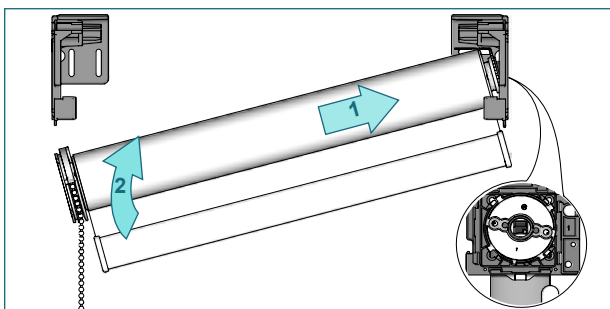

Place the shade with the idle end onto the bracket. Push the shade against tube bearing plug and lift it up ...

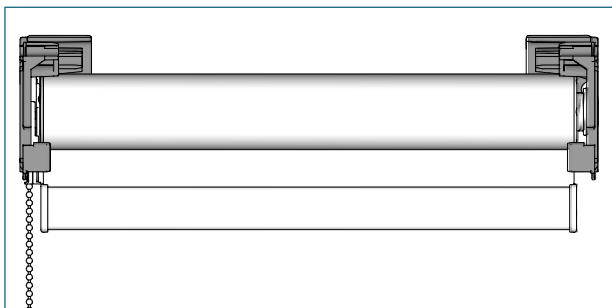

...line up teeth of the clutch with bracket and insert.

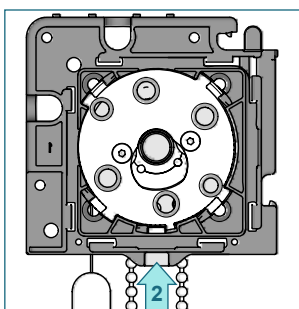
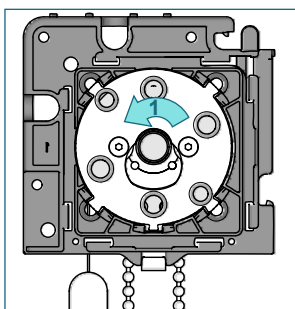

Turn the shade (10°) in the rolling off direction (1) and secure it with the locking clip (2).

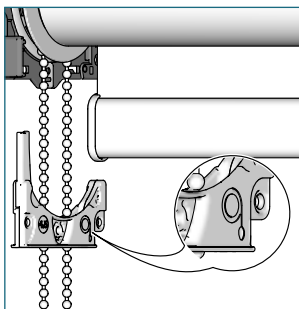
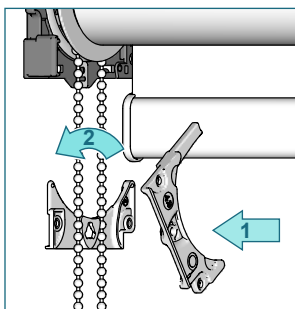

Put the chain between the chain outlet. Pay attention that stamping and roll-off direction of the shade are identical. Put the parts together (1) and turn left for closing (2).

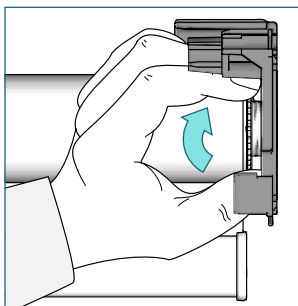
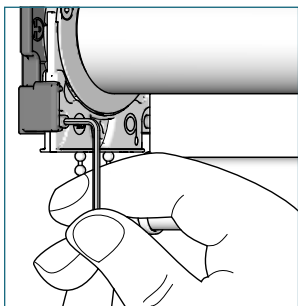

Slide the chain outlet up to the clutch and attach on the bracket with the 2 screws provided. Secure the shade by turning the locking ring away from the bracket.

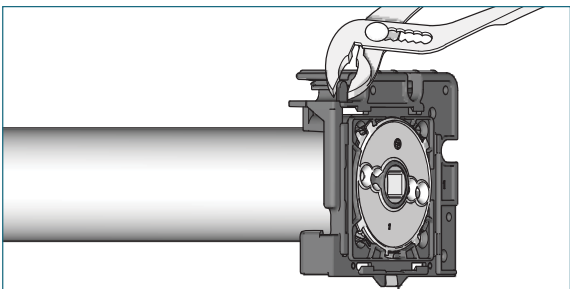

Use a pair of pliers to break off the stopper from the intermediate bracket.



Install the outer bracket with the screws provided.

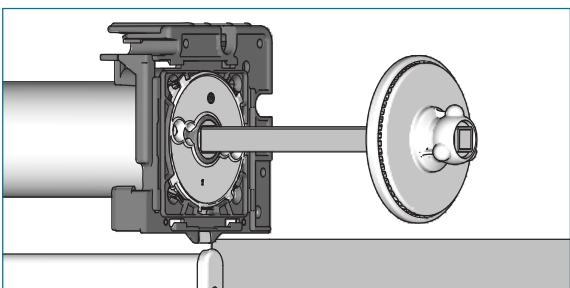

Slide the aligner or the connector set through the intermediate bracket into the tube bearing plug.

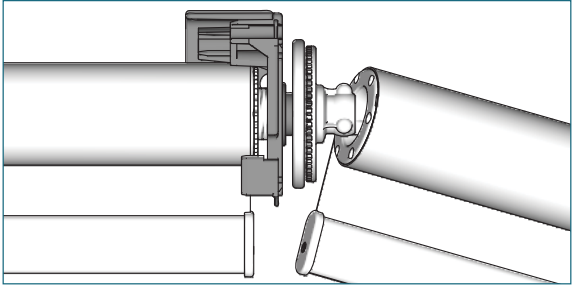

Place the tube with plug connector on the aligner or connector set head.

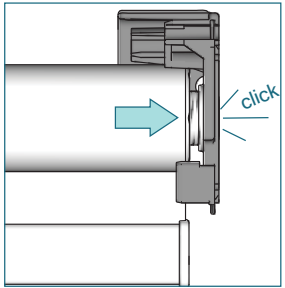
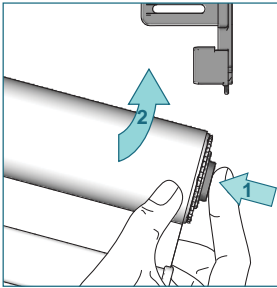

Press the tube bearing plug, lift the roller shade and snap it into the bracket.

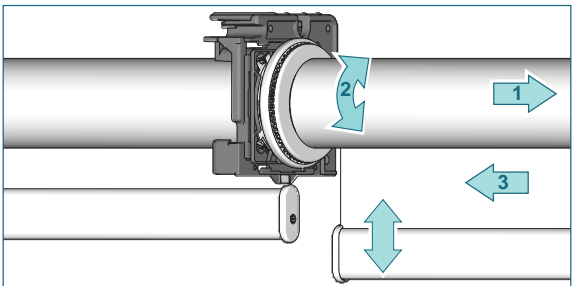

To align the bottom hembar, pull the shade away from aligner set (1), turn shade to line up bottom hembar together (2). Release shade to secure position (3). Not possible when using connector set.

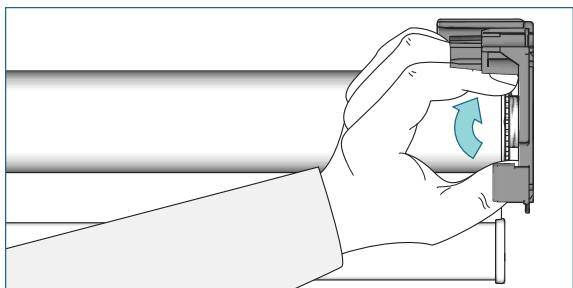

Secure shade band by turning the locking ring on tube bearing plug furthest away from the bracket.

Option: Leveler

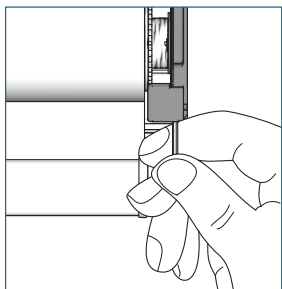
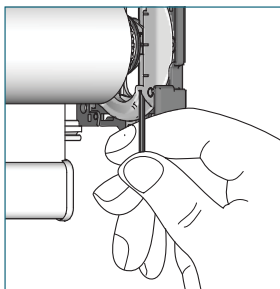

To adjust skewing, put the provided Allen key into the screw of the leveler and turn it left or right to move the shade up and down. Support lifting of large heavy roller shades with the palm of your hand.

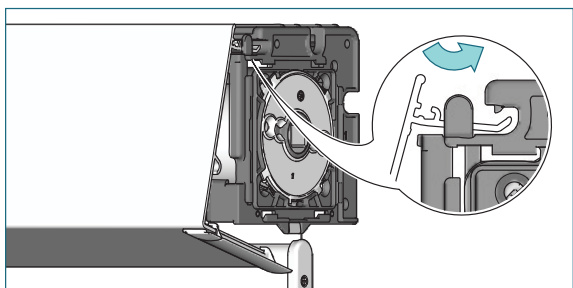

Place the fascia in the bracket. Make sure that the fascia slides under the nose of the bracket.

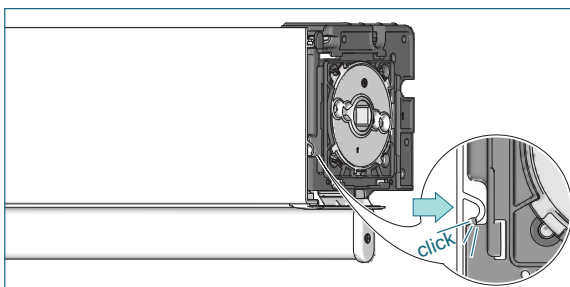

Push the fascia to snap it into the bracket.

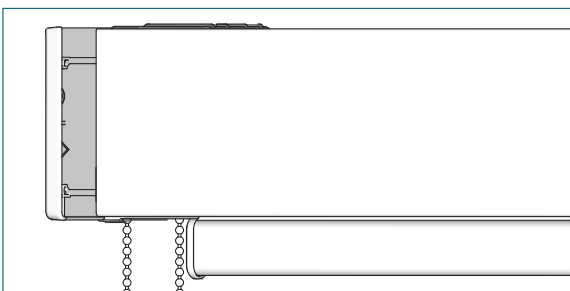

Slide the bracket covers onto the brackets.

Removal

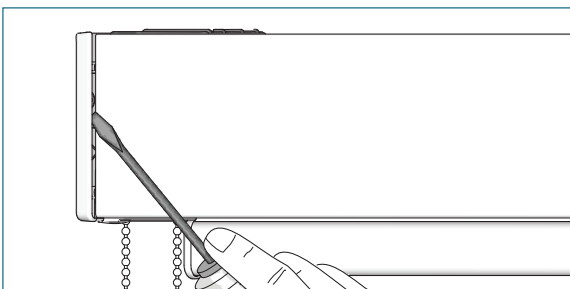

Place the screw driver under the bracket cover, turn the screw driver and slide the bracket cover from the bracket.

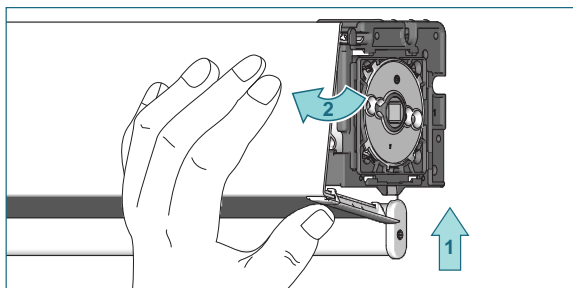

Press the bottom of the fascia upwards (1) and pull it outwards (2).

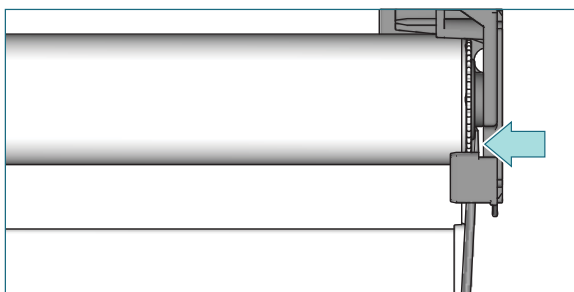

Unfasten the locking ring. Slide a screw driver between locking ring and bracket and push the tube bearing plug in the aligner/connector direction.

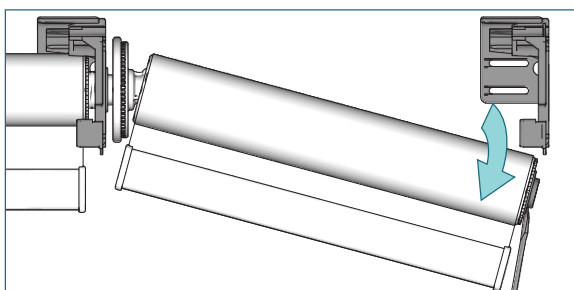

Move the roller shade downwards out of the bracket. Pull the aligner or connector out of the idle end.