

# ShadeSense Alternative Wood Blinds

## WHY CHOOSE SHADESENSE?

ShadeSense Alternative Wood Blinds are a cost-effective alternative to wood and composite wood blinds. Constructed from engineered polymer, ShadeSense blinds are durable, easy to clean, and simple to maintain.

Ideal for large-scale projects, explore 24 colorways that will elevate any space.

## KEY FEATURES

2" and 2 1/2" Flat Slats of Engineered  
Polymer Material

Safe for Kids and Pets

Cordless Lift with Balanced Spring  
Motor for Enhanced Safety

Increased Privacy and Light Control

Easy to Mount

Backed by our Lifetime Guarantee



# ShadeSense Alternative Wood Blinds

## | Color Options

All colors shown are available in the 2" slat.

\* denotes colors available in the 2-1/2" slat.

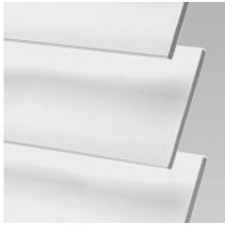

377 & 477\* White



378 & 478\* Extra  
White

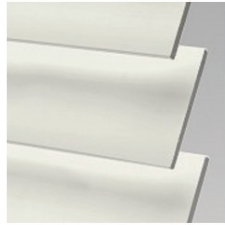

379 & 479\* Pure  
White

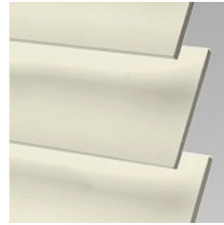

380 & 480\* Roman  
White

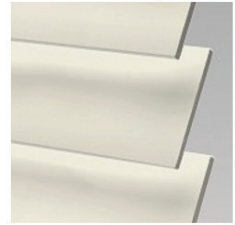

381 & 481\* Incredible  
White

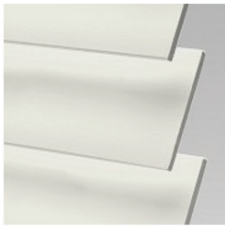

376 & 476\* Antique  
White

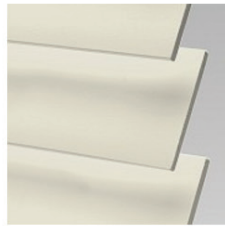

374 & 474\* Ivory

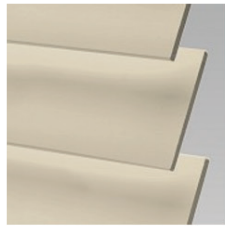

375 & 475\* Alabaster



902 & 502\* Pewter

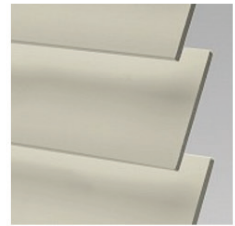

903 & 503\* Warm  
Gray

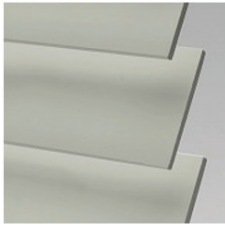

905 & 505\* Steel

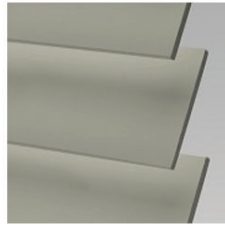

901 & 501\* Light Gray

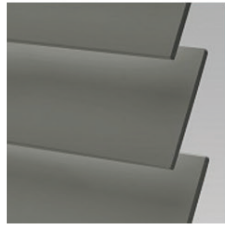

904 & 504\* Dark Gray



T377 White Textured



T379 Pure White  
Textured



T376 Antique White  
Textured



T902 Pewter Textured



T903 Warm Gray  
Textured

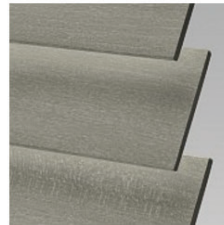

362 Gray Wash

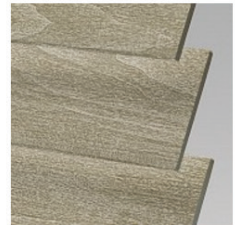

361 Sea Mist

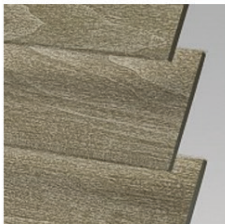

363 Ashwood



801 Pine



802 Maple

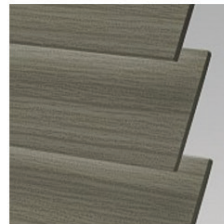

803 Smoke

# ShadeSense Alternative Wood Blinds

## ShadeSense Alternative Wood Blinds Cordless

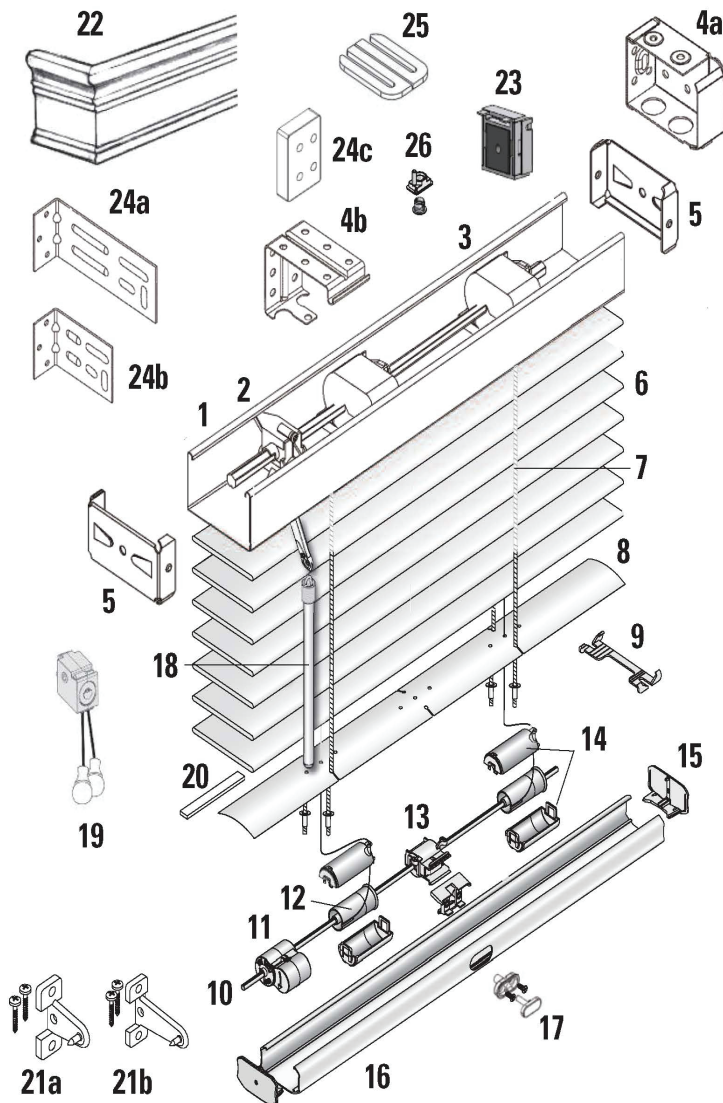

### PRODUCT COMPONENTS – CORDLESS LIFT & LOCK™

#### STANDARD PARTS

1. Slim Design Headrail
2. Wand Tilter
3. Tape Drum
- 4a. Installation Bracket
- 4b. Center Support Bracket
5. End Lock End Stiffener
6. Faux Wood Slats
7. Lift Cords
8. 2" Aluminum Slat
9. 2" Top Slat Clip
10. "V" Tiltrod
11. Lift & Lock Motor
12. Lift 7 Lock Spool
13. 2" Lock Assembly
14. Support and Cover Set
15. Lift & Lock Bottomrail End Cap
16. Lift & Lock Bottomrail
17. Lift & Lock Button Screw
18. Wand Tilt
19. Cord Tilter
20. Foam Tape

#### OPTIONAL PARTS

- 21a. Lift & Lock Hold Down Brackets, Sill
- 21b. Lift & Lock Hold Down Brackets, Jamb
22. Valance
23. Magnetic Valance Clip
- 24a. Long Extension Bracket
- 24b. Short Extension Bracket
- 24c. Spacer Block
25. Bracket Shim
26. Cord Screw Adjuster