

FR Skyline® Gliding Window Panels



FR Skyline® Gliding Window Panels traverse horizontally across the window on a slim track. This innovative system features a smooth, reliable mechanism and a selection of sophisticated shading fabrics.

KEY FEATURES

- Patented dual-channel, single track covers widths up to 384" and drops as tall as 168", standard and motorized units available
- Most fabrics are GREENGUARD Gold certified for low-emitting products
- Fabrics meet all requirements of NFPA 701 small scale flammability testing for commercial applications
- Color-coordinated hardware
- Multiple designer top treatment options available
- Interlocking bottom-weight increases panel stability and eliminates tangling
- Lifetime Guarantee



(0% Openness) Flocke



Blanc



Sahel



Mississippi



Chartreux



Loutre

(5% Openness) Exotic Hues



Patagonian
Glacier



Chamorro
Coconut

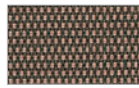

Palmira Teak

(10% Openness) Bamboo



Birch

(10% Openness) New Orleans

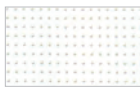

Riverboat White

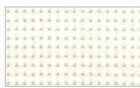

Magnolia



Wrought Iron

(14% Openness) Sheerweave 3000



White



Sand

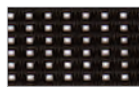

Chocolate

Hardware Colors

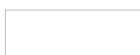

White Tiara



Rich Cream

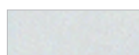

Duchess Gray



Nickel



Desert Gold



Gold



Desert Tan



Bronze



Black

HunterDouglas 
Architectural

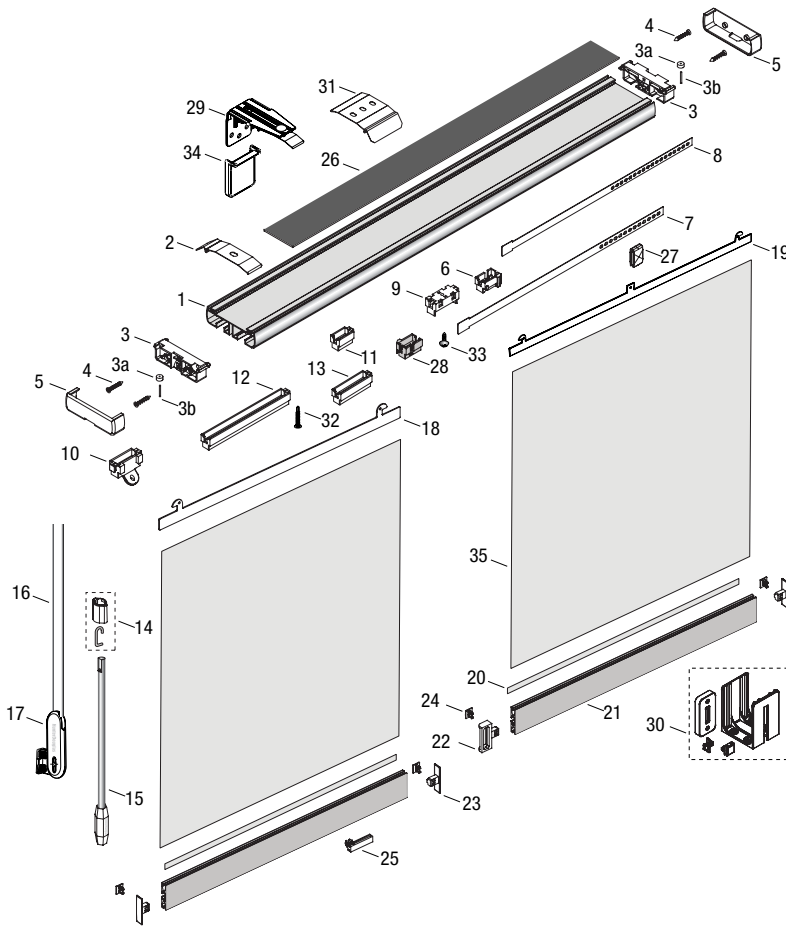

STANDARD COMPONENTS:

- | | |
|------------------------------|---------------------------|
| 1. Headrail (2½" X ¾") | 19. 17" Fabric Hanger |
| 2. Mounting Clip | 20. Bottom Weight |
| 3. End Cap | Mounting Strip |
| a. Cord Wheel | 21. Bottom Weight |
| b. Axle | 22. Snap Slide End Cap |
| 4. End Cap Screw | 23. Bottom Weight End Cap |
| 5. Outside End Cap | 24. End Cap Pin |
| 6. Right Facing Carrier | 25. Snap Slide |
| (white) | 26. Sound Deadening |
| 7. 17" Carrier Spacer Link | Material |
| 8. 11½" Carrier Spacer Link | 27. 17" Fabric Hanger |
| 9. Cord Driver | Center Support Cap |
| 10. Wand Driver | 28. Left Facing Carrier |
| 11. Small Spacer | (Grey) |
| 12. Big Spacer | 29. 3½" L Bracket w/Clip |
| 13. Medium Spacer | 30. Room Divider Kit |
| 14. Wand Sleeve | 31. Headrail Splicer Clip |
| 15. Wand Assembly | 32. Carrier Locking Screw |
| 16. Traverse Cord | 33. Cord Lock Screw |
| 17. Universal Cord Tensioner | 34. Bracket Cover |
| 18. 11½" Fabric Hanger | 35. Panel Fabric |

PRODUCT SPECIFICATIONS

PART 2 – PRODUCTS

2.01 ACCEPTABLE MANUFACTURER

- A. Hunter Douglas Architectural / 13915 Danielson St., Ste.100/ Poway, CA 92064 / Phone: 800-727-8953 / Fax: 800-205-9819 / Website: HDarchitectural.com or architect approved equivalent.
- B. Product substitutions must be approved by architect minimum of 30 days prior to close of bid.

2.02 PANEL TRACK SYSTEMS

- A. **PRODUCT:** Hunter Douglas "Skyline® FR Gliding Window Panels"
- B. **MATERIALS:**
 - 1. **FABRICS:** Inherently anti-static, flame retardant, fade and stain resistant fabrics providing 0% - 14% openness factors. Fabric weights to range between 11.79 oz/sq.yd. – 14.60 oz/sq.yd. containing fiberglass, PVC, polyester, & vinyl coatings. Finish selected by architect from manufacturer's available contract colors. Panel widths available in 11 ½" and 17".
 - 2. **CHANNEL:** Patented anodized aluminum dual channel single track system measuring 2 ½" X ¾". Internally fit with components required for specified performance and designed for smooth, quiet, trouble-free operation.
 - 3. **TRAVERSING:** Stretch resistant, non-fraying, and lint-free lock knit polyester cord provides traversing capabilities for left, right, and split stack draws. Single wand or dual wand control (for split stack units) or PowerView™ Motorization available.

- 4. **BOTTOM WEIGHT:** Powder coated color-coordinated aluminum interlocking bottom weight provides panel stability and alleviates panel tangling.
 - C. **MOUNTING HARDWARE:** Manufacturer's standard L- bracket with clip (outside mounts) and clip only (inside mounts) provide required support. OB brackets are color-coordinated to hardware on shade; IB/CB brackets are not visible once shade is mounted.
 - D. **ADDITIONAL AVAILABLE OPTIONS:** Top treatment options – sleek metal valance, or box valance for room dividers, or fabric wrapped large cassette.
- #### 2.03 FABRICATION
- A. Shade measurements shall be accurate to within + 1/8" or as recommended in writing by manufacturer.
- #### 2.04 FABRICS
- A. **FABRIC** selection from the following: (0% Openness) Flocke: Blanc, Sahel, Mississippi, Chartreux, Loutré, Encre. (5% Openness) Exotic Hues: Patagonian Glacier, Chamorro Coconut, Palmira Teak. (10% Openness) Bamboo: Birch. (10% Openness) New Orleans: Riverboat White, Magnolia, Chicory, Dijon, Vanilla Belle, Wrought Iron. (14% Openness) SheerWeave 3000: White, Sand, Chocolate.
- #### 2.05 FINISHES
- A. **HARDWARE** finish selection from the following: Bronze 064, Dusty Green 204, Gold 235, Desert Gold 907, Rich Cream 320, White Tiara 661, Desert Tan 859, Duchess Gray 651, Nickel 307, Black 048