

HunterDouglas

Installation • Operation • Care

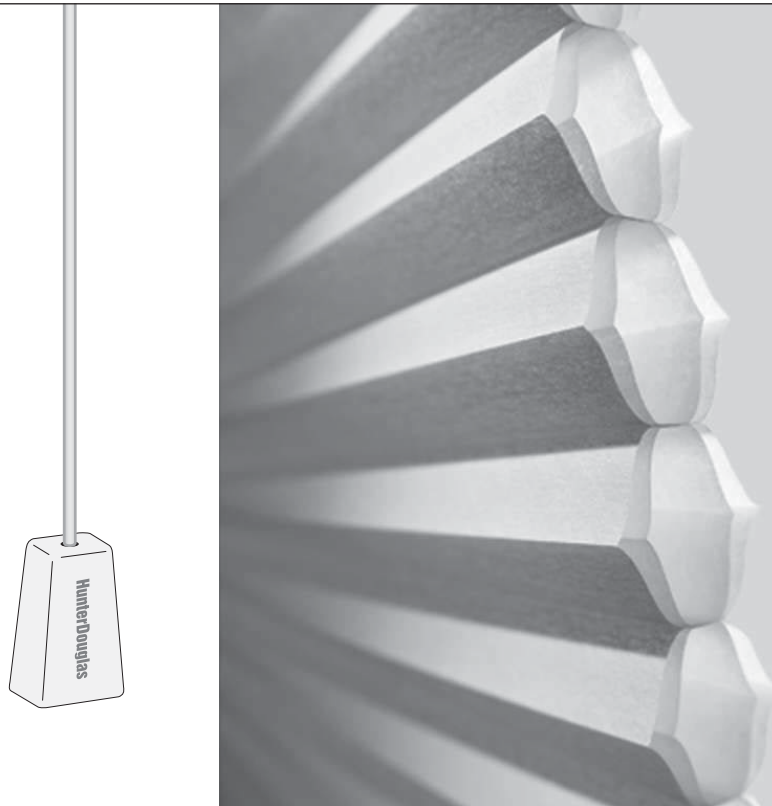

Duette® and Applause®
Honeycomb Shades
Cordlock Lifting Systems

CONTENTS

Getting Started:

Mounting Types And Window Terminology 1
Installation Components Needed 1
Optional Components 2
Tools And Fasteners Needed 2
Product View 3

Installation:

Mount The Installation Brackets — Inside Mount 4
Mount The Installation Brackets — Outside Mount 5
Mount The Installation Brackets — End Mount 6
Install The Shade 7
Attach The Hold-Down Brackets (Optional) 8

Operation:

Operate The Shade 8
Troubleshooting 9

Care:

Cleaning Procedures 12
Remove The Shade 13

Child Safety:

Warning 14

Questions?

Call the Hunter Douglas Customer Information Center at
1-888-501-8364.



GETTING STARTED

Thank you for purchasing Hunter Douglas Duette® or Applause® cordlock honeycomb shades. With proper installation, operation, and care, your new shades will provide years of beauty and performance. Please thoroughly review this instruction booklet before beginning the installation.

Mounting Types And Window Terminology

If the installation brackets are mounted correctly, the rest of the installation process follows very easily. To prepare for this important first step, review the mounting types and basic window terminology illustrated below.

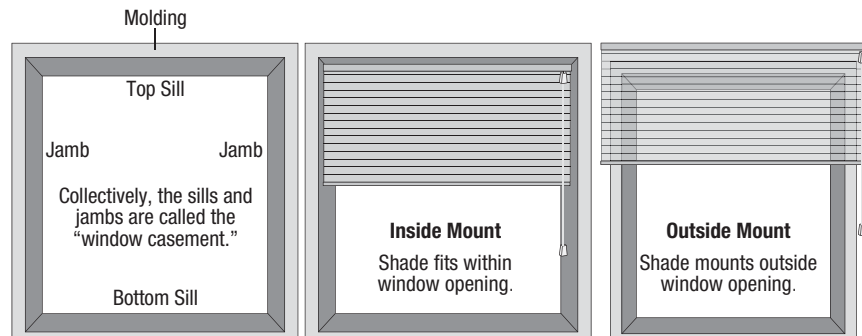

Installation Components Needed

Check the packaging to be sure you have all the components needed to install your shades. Keep the packaging until the shades perform to your satisfaction.

Shade Width	Brackets Required
12" – 31"	2
31 ¹ / ₈ " – 79"	3
79 ¹ / ₈ " – 96"	4
96 ¹ / ₈ " – 139"	5
139 ¹ / ₈ " – 174"	6

Required Components

■ **Installation Brackets.** The number of installation brackets required varies with shade width, as shown in the table. Your order will include one of the following types of installation brackets.

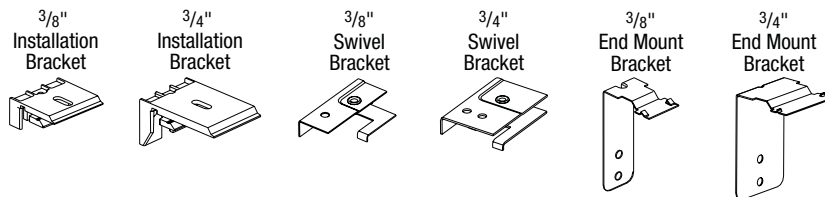

IMPORTANT: For illustration purposes, the 3/4" installation brackets are shown throughout the following instructions. The 3/8" brackets follow these same installation procedures.

GETTING STARTED

Optional Components

- **Extension Brackets.** Extension brackets can add up to 3 1/2" of clearance for outside and end mounts. If ordered, there should be the same number of extension brackets as installation brackets.
- **Spacer Blocks.** Each spacer block projects the installation bracket 1/2" away from the mounting surface. If ordered, there should be a maximum of three spacer blocks per installation bracket.
- **Hold-Down Brackets.** Hold-down brackets provide stability and prevent swaying by securing the bottom rail (i.e. often used in French door applications).

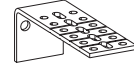

Extension Bracket



Spacer Block

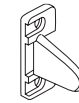

Hold-Down Bracket
(Outside Mounts Only)

Tools And Fasteners Needed

- Flat blade and Phillips screwdriver
- Measuring tape and pencil
- Level
- Power drill, 3/32" drill bit, and a 1/4" hex driver

In addition, you will need fasteners designed to work with your specific mounting surface(s).

- **#6 Hex Head Screws (Provided).** Two 1 1/2" screws are provided per installation bracket.
- **Longer #6 Hex Head Screws (Not Provided).** If using spacer blocks, use a #6 mounting screw long enough for a secure attachment.
- **Wall Anchors (Not Provided).** If mounting into drywall, you will need wall anchors to ensure a secure installation.
- **Speed Nuts and Screws (Provided).** Extension brackets come with screws and speed nuts.



#6 x 1 1/2"
Hex Head Screw
(Provided)



Longer #6 Hex Head Screw
For Use With Spacer Blocks
(Not Provided)



Wall Anchor Or
Expansion Bolt
(Not Provided)



Speed Nut
And Screw
(Provided With Each
Extension Bracket)

GETTING STARTED

Product View

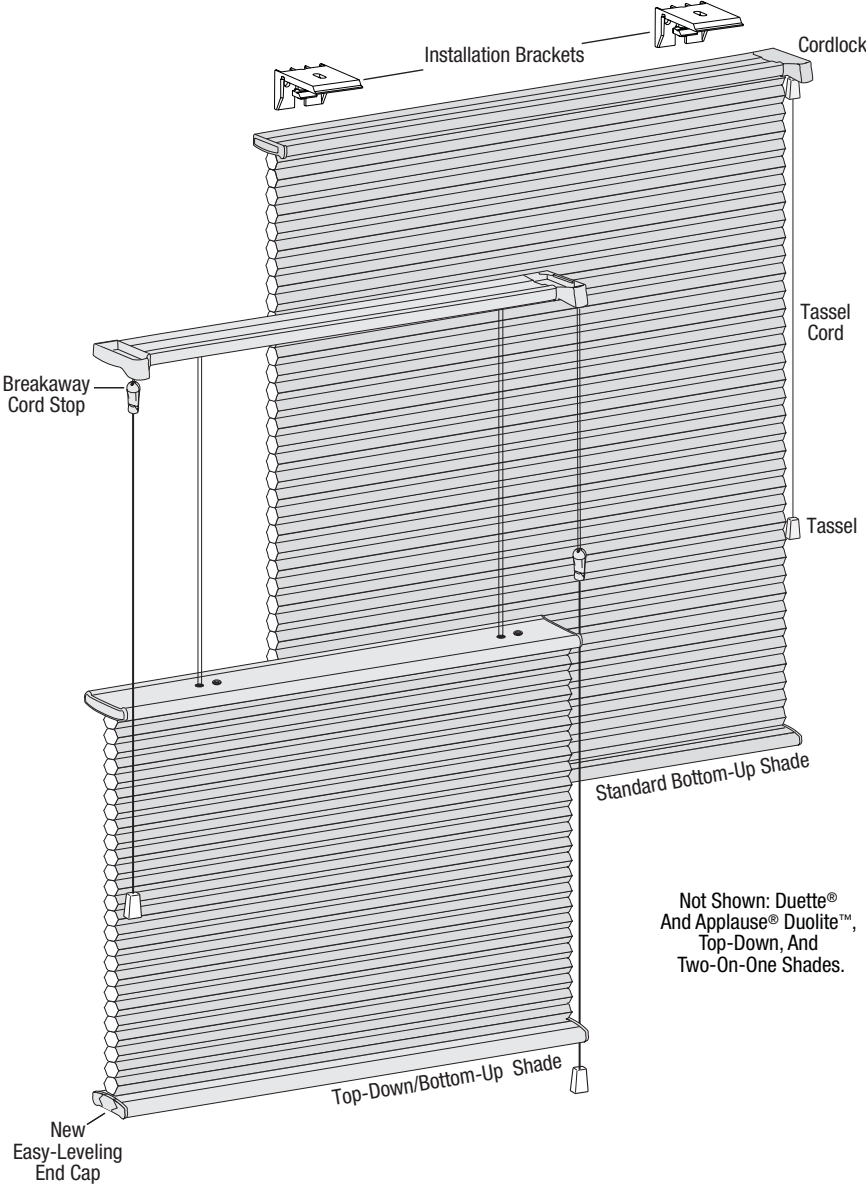

INSTALLATION

Mount The Installation Brackets — Inside Mount

- Measure and mark 3" in from each jamb for end bracket location.
 - If more than two installation brackets came with your order, space additional bracket(s) evenly between the two end brackets.

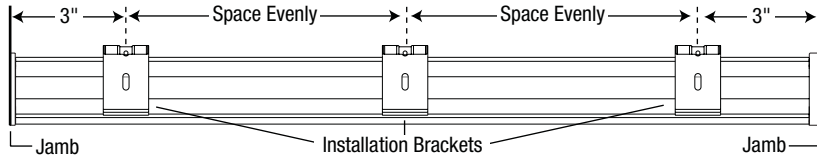

- Center each installation bracket on the marks and mark the location for the screw hole.
 - The depth required for minimum mounting or fully recessed mounting will vary depending on the pleat size of the fabric. Refer to the chart for depth requirements.
 - Check that the mounting surface is level and the brackets are aligned. Shim the brackets if necessary. (Shims not provided.)

Bracket Type	Minimum	Fully Recessed
3/8" Standard	1"	1 5/8"
3/4" Standard*	1 1/4"	2 3/8"
3/8" Swivel	1/2"	1 1/4"
3/4" Swivel	1/2"	2"

*Double and triple honeycomb fabrics use 3/4" bracket.

- Drill the screw hole using a 3/32" drill bit.

IMPORTANT: If you are fastening the installation brackets into drywall only, be sure to use wall anchors and follow the instructions provided with the anchors. (Anchors not provided.)

- Fasten the installation brackets to the mounting surface using the hex head screw provided.

IMPORTANT: The 3/4" swivel installation bracket has two holes in the bracket:

- Use the front hole if a 1 1/4" mounting depth is available.
- Use the rear hole if the mounting depth is between 1/2" and 1 1/4".

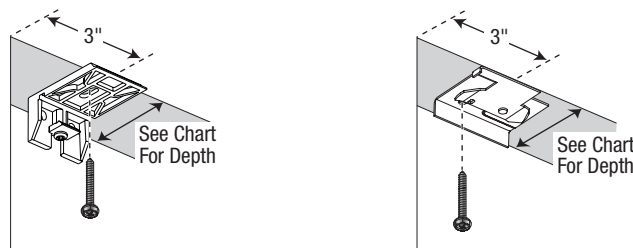

INSTALLATION

Mount The Installation Brackets — Outside Mount

- Center the headrail over the window opening at the desired height. Use a pencil to lightly mark each end of the headrail.
- Measure and mark 3" in from each end of the headrail.
 - If more than two installation brackets came with your order, space additional bracket(s) evenly on studs, between the two end brackets and mark their location.

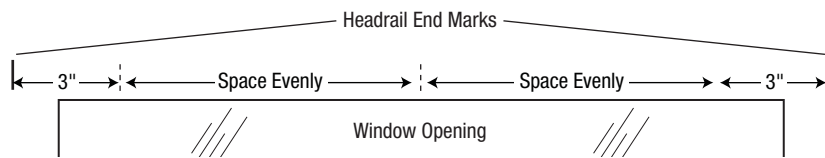

- Center each installation bracket on the marks and mark the location for the screw holes.
 - A minimum flat vertical surface of $\frac{5}{8}$ " for a $\frac{3}{8}$ " bracket, or 1" for a $\frac{3}{4}$ " bracket is required.
 - The top of the installation brackets should be at the desired height. The brackets should be level and aligned.

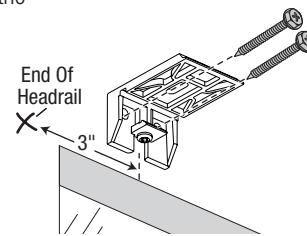

CAUTION: The rear of the brackets must be flush against a flat mounting surface.
Do not mount brackets on curved molding.

- Drill the screw holes using a $\frac{3}{32}$ " drill bit.

IMPORTANT: If you are fastening the installation brackets to drywall, be sure to use wall anchors and follow the instructions provided with the anchors. (Anchors not provided.)

- Fasten installation brackets to the mounting surface using the hex head screws provided.
- If using spacer blocks, fasten these to a flat vertical mounting surface with two screws long enough for a secure installation (Screws not provided.)
 - The solid side of the spacer blocks faces the mounting surface.
 - Use a maximum of three spacer blocks per installation bracket.

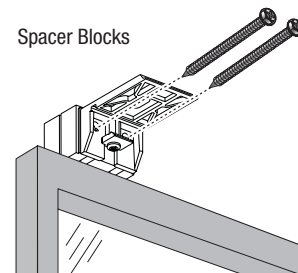

INSTALLATION

- When using extension brackets, attach an installation bracket to the underside of each extension bracket using the provided screws and speed nuts.

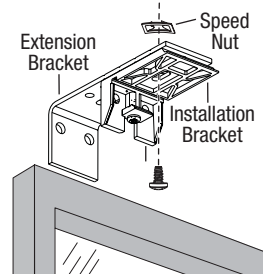

Mount The Installation Brackets — End Mount

End mount the headrail when conventional mounting techniques will not work, for example, in an arched window.

Thread And Install The Tension Support Bracket (For Shades Wider Than 36")

- Thread the support cord down through Hole 1.
- Bring the cord up through Hole 2 and then down through Hole 3.
- Pull the end of the cord through the loop and pull the loop closed.
- Pull the end cap out of the headrail.
- Insert the tension support bracket, knot side down, under the edges of the headrail.
- Move the bracket to the center of the headrail.

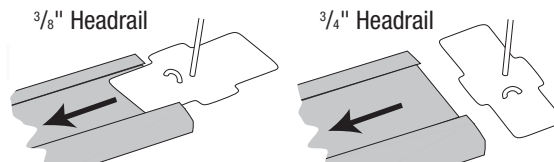
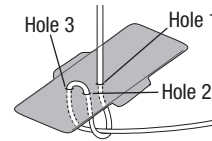

Install End Mount Brackets Onto The Headrail

- On the end without cords, remove the end cap from the headrail.
- Insert the bracket under the headrail edges.
- Replace the end cap and push the bracket and end cap snugly into the headrail.
- To install bracket on the cordlock side, pull the shade cord to the center of the shade to release the lock, as if lowering the shade.
- Pull the cordlock out $\frac{1}{2}$ " and insert the bracket under the headrail edges.
- Place the cordlock back into the headrail and push the bracket and cordlock snugly into the headrail.

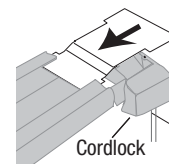
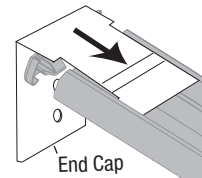

INSTALLATION

Install The Headrail Into The Window

- Position the fully lowered shade in the window.
- Gently push the fabric away from the bracket to allow access to the bracket screw holes.
- Secure the brackets to the mounting surface using two screws per bracket.
- If a tension support bracket was installed, attach a screw or hook into the mounting surface directly above the tension support bracket.
- Tie the cord from the tension support bracket to the screw or hook.

Install The Shade

Standard Brackets

- Position the shade so that the cords face you.
- Slip the headrail into the installation brackets so the front of the bracket slides under the front groove on the top of the headrail.
- Gently roll the back of the headrail up and push back to snap into place.
- Tighten the tab screw.

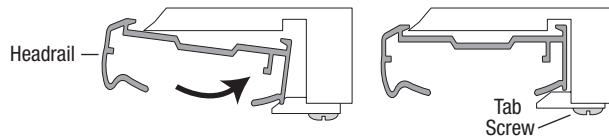

Swivel Brackets

- Place the swivel brackets in the open position.
- Place the headrail against the back of the installation brackets.
- Rotate the swivel arm to snap the locking tab under the headrail.
- The shade is locked when the push tab is against the headrail.

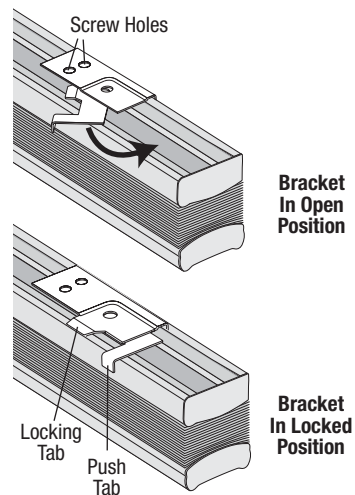

OPERATION

Attach The Hold-Down Brackets (Optional)

Hold-down brackets are only used on outside mounted shades.

- Lower the shade and place the pins from the hold-down brackets into the bottom rail end caps.
- On the mounting surface, mark the bracket hole locations.
- Check that the brackets are level and aligned, and attach them to the mounting surface using two screws.

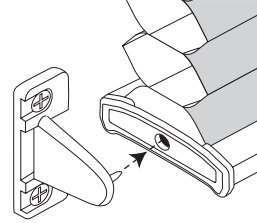

Operate The Shade

IMPORTANT: Duolite™, Top-Down/Bottom-Up, and Two-On-One Headrail shades have two operating cords. Top-Down shades have one operating cord.

FOR LARGER SHADES there are two sets of operable cords from each cordlock. Be sure to pull evenly on both cords from each cordlock, when raising or lowering the shade.

- Keep the cord close to the fabric when operating the shade.
- To raise or lower the shade, disengage the cordlock by moving the cord toward the center of the shade.
- Pull on the cord to raise the shade.
- Engage the cordlock by returning the cord to the original position.

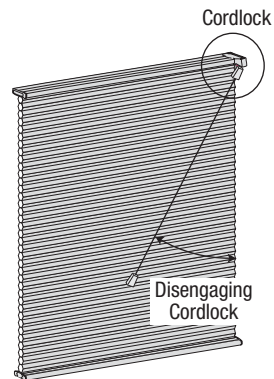

Duolite And Top-Down/Bottom-Up Shades

- To operate Duolite and Top-Down/Bottom-Up shades, the right cord operates the center rail and the left cord operates the bottom rail.

IMPORTANT: You must first lower the bottom rail before lowering the center rail. Likewise, you must first raise the center rail before raising the bottom rail.

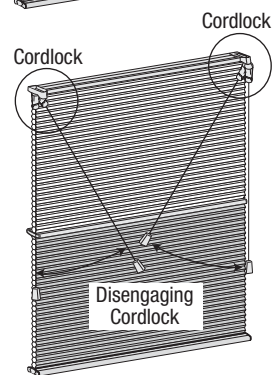

Troubleshooting

Problem	Solution
The shade will not fit into the installation brackets.	<ul style="list-style-type: none"> ■ Check that the installation brackets are level and aligned. Adjust and/or shim to level, if necessary. ■ Be sure the heads of the mounting screws are flush against the installation bracket. ■ Make sure that the shade fabric is not caught between the installation bracket and the headrail.
The shade is hard to raise or lower, or will not raise or lower.	<ul style="list-style-type: none"> ■ Check that the headrail and installation brackets are level and aligned in the window. The window may be out of square. To check if the window is square, measure the diagonals. Level the headrail by shimming the installation brackets, if necessary. ■ Check that lift cords/pull cords are not pinched or tangled. ■ Make sure that the shade fabric is not caught between the installation bracket and the headrail. ■ If hold-down brackets are used, make sure they have been released before operating the shade.
The shade will not lower when pulling the cord.	<ul style="list-style-type: none"> ■ Check to see if the locking mechanism in the cordlock is released. ■ Pull the cord toward the center of the shade at about a 45° angle, to release the cordlock. Then let go of the cord to lower the shade.
The shade will not stay in the raised position.	<ul style="list-style-type: none"> ■ To lock the shade in the raised position (or anywhere along the path to the fully raised position), engage the cordlock by pulling the cord toward the outside of the shade.

OPERATION

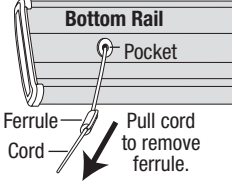
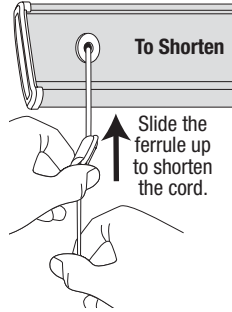
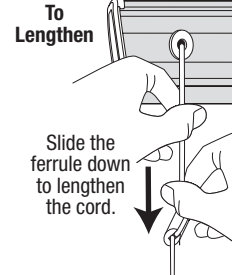
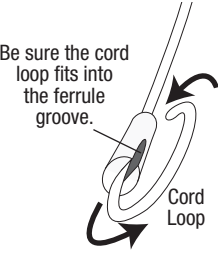
Problem	Solution
<p>The bottom rail is not level, or the shade height is incorrect.</p>	<p>Shade Height Adjustment</p> <p>Shade height and adjustments to level the bottom rail can be made by adjusting the cord on the underside of the bottom rail.</p> <ul style="list-style-type: none"> ■ Locate the ferrule, seated in a pocket in the bottom rail. ■ Remove the ferrule by pulling on the excess cord. If the cord has been trimmed, you will need to use needlenose pliers to access it. ■ To shorten the cord, hold the cord tight under the ferrule. Then slide the ferrule up toward the pocket. ■ To lengthen the cord, hold the cord tight between the pocket and the ferrule. Then slide the ferrule down. ■ After adjusting, place the ferrule fully back into the pocket. ■ Once you are certain of the final adjustments, tape the extra cord length to the bottom rail, or into the groove on the bottom rail (for future adjustments). <div style="display: flex; align-items: center;">  <div style="margin-left: 10px;"> <p>Bottom Rail</p> <p>Pocket</p> <p>Ferrule</p> <p>Cord</p> <p>Pull cord to remove ferrule.</p> </div> </div> <div style="display: flex; align-items: center; margin-top: 10px;">  <div style="margin-left: 10px;"> <p>To Shorten</p> <p>Slide the ferrule up to shorten the cord.</p> </div> </div> <div style="display: flex; align-items: center; margin-top: 10px;">  <div style="margin-left: 10px;"> <p>To Lengthen</p> <p>Slide the ferrule down to lengthen the cord.</p> </div> </div>
<p>The ferrule has come off the cord. How do I rethread the ferrule?</p>	<ul style="list-style-type: none"> ■ Thread the end of the cord into the tapered end of the ferrule. Loop the end around the ferrule and back through the tapered end. Make sure the loop fits into the groove on the side of the ferrule. <div style="display: flex; align-items: center;">  <div style="margin-left: 10px;"> <p>Be sure the cord loop fits into the ferrule groove.</p> <p>Cord Loop</p> </div> </div>

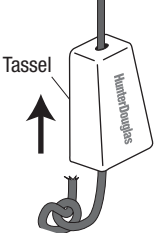
Problem	Solution
<p>The tassel cord length is too long.</p>	<p>Adjust The Tassel Cord Length</p> <p>The tassel cord length is usually $\frac{2}{3}$ the length of the fully closed shade. To shorten the tassel cord:</p> <ul style="list-style-type: none"> ■ Slide the tassel up the cord revealing the knot. ■ Make a new knot below the tassel at the desired location. ■ Trim the excess cord below the knot. ■ Slide the tassel back down over the the knot. 

CARE

Cleaning Procedures

Hunter Douglas honeycomb shades are made of an anti-static, dust-resistant fabric which repels dirt and dust. For most honeycomb fabrics, the following options are available if your shade needs cleaning.

Dusting

- Regular light dusting with a feather duster is all the cleaning that is needed in most circumstances.

Vacuuming

- For deeper cleaning, vacuum gently with a brush attachment.

CAUTION: Do not vacuum Architella® Elan™ or Architella Elan Eclipse™ fabrics.

Compressed Air/Hair Dryer (Cool Setting)

- Use compressed air or a hair-dryer on a cool setting, to blow dust and dirt off of shades.

Spot-Cleaning

- Prepare a solution of warm water and a mild detergent.
- Dampen a clean cloth in the solution and wring it out.
- Dab the spot with the dampened cloth until it is gone. Do not rub the fabric.
- Allow the shade to dry in the completely lowered position.

CAUTION: Do not spot-clean Batiste, Opalescence™, Puressence™, or Royale fabrics.

Bathtub Cleaning/Water Immersion

- Immerse the shade in a basin or bathtub filled with a mild detergent. Never immerse the headrail into the solution.
- Rinse with clean water.
- Before removing from the rinse water, fully raise the shade and tilt it to allow excess water to drain off.
- Reinstall the damp shade, lower it, and let it dry completely.

CAUTION: Do not immerse Commercial, Puressence, Royale, all opaque fabrics, or any fabric-covered valances.

Ultrasonic Cleaning

- Some honeycomb fabrics can be ultrasonically cleaned by a professional.
- Specify that a mild detergent solution be used.
- Never immerse the headrail into the solution.
- Dry the shade completely in the lowered position.

CAUTION: Do not ultrasonically clean Casuelle® , Commercial, Opalescence™ , Purescence™ , all opaque fabrics, or any fabric-covered valances.

Injection/Extraction Cleaning

- This type of professional cleaning injects a cleaning solution into the fabric and extracts the dirty solution in the same motion.
- A dry method of injection/extraction is required for Architella®, Casuelle, Commercial, Opalescence, Panache™ , Sunterra™ , and any opaque fabrics.
- If using injection/extraction for Batiste fabrics, specify that no chemicals are used (water only).
- Never immerse the headrail into the solution.

CAUTION: Do not use injection/extraction cleaning on Purescence fabrics, or any fabric-covered valances.

Remove The Shade

- Fully raise the shade.
- Unscrew the tab screw on each bracket to release the headrail.

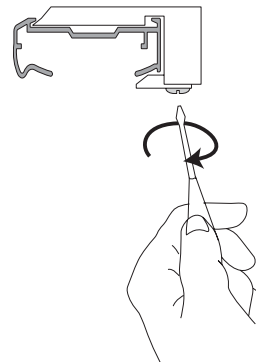

CHILD SAFETY



! WARNING

For more safety information call 1-888-501-8364 in the U.S. or 1-866-662-0666 in Canada.

Young children can wrap cords around their necks and STRANGLE.

- **Always keep cords out of the reach of children.**
- **Move cribs, playpens and other furniture away from cords.** Children can climb furniture to get to cords.
- **Do not tie cords together.** Make sure cords do not twist together and create a loop.

Hunter Douglas provides cord cleats and we recommend their use.

- **Cord Cleats:** Attach two cord cleats 6" to 12" apart at a height where they will be out of the reach of children. Take into account that a child may stand on furniture attempting to reach the cords. Be sure the cleats are firmly secured. Once the cleats are attached, wrap excess cord around them after each use of the shade.



Breakaway Cord Stop

To further reduce the hazards of entanglement and strangulation, breakaway cord stops are provided with Honeycomb Top-Down/Bottom-Up and Duolite™ shades. They are designed to break apart when force is applied from the top.

IMPORTANT: Should the breakaway cord stop break apart, be sure to untangle the cords prior to reassembling.

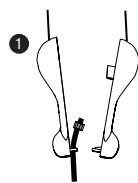

Breakaway
Cord Stop

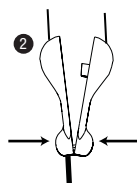

Fit the bottom
edges together.

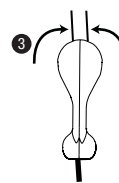

Swing the top
edges together
and snap close