

# 2" First Edition™

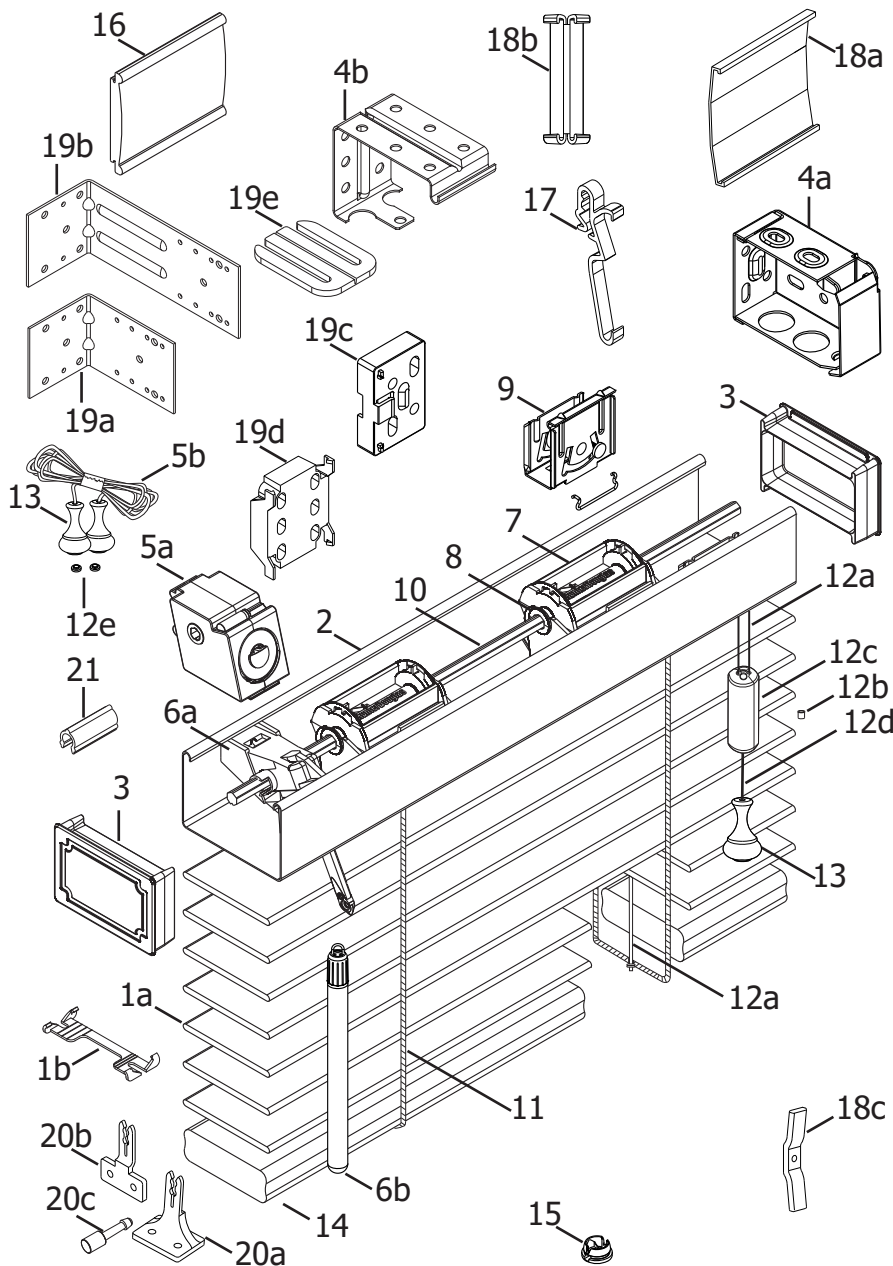

## Standard Parts

- 1a. Slat
- 1b. Tape Spacer
2. Headrail
3. Headrail End Cap
- 4a. Installation Bracket
- 4b. Intermediate Support Bracket
- 5a. Cord Tilter
- 5b. Tilt Cord 1.4mm
- 6a. Wand Tilter
- 6b. Tilter Protector
- 6c. Wand
7. Tape Roll 2" Univ. Epic™
8. Support Tape Roll (Ladders)
9. Cordlock
10. Tiltrod
11. No Loop Cable Tape
- 12a. Lift Cord 1.4mm
- 12b. Cord Stop Washer
- 12c. Cord Stop
- 12d. Tassel Cord 2.2mm
- 12e. Lift Cord Grommet
13. Wood Tassel
14. Bottom Rail
15. Tape Button
16. Valance
17. Universal Valance Clip
- 18a. Valance Splice
- 18b. Universal Valance Corner Key
- 18c. Child Safety Kit (Cord Cleat)

## Optional Parts

- 19a. Short Extension Bracket
- 19b. Long Extension Bracket
- 19c. Spacer Block (Bracket)
- 19d. Spacer Block (Support Bracket)
- 19e. Bracket Shim
- 20a. Hold-Down Bracket (Sill)
- 20b. Hold-Down Bracket (Jamb)
- 20c. Hold-Down Pin
21. Clip

## 2" First Edition™

<b>No.</b>	<b>PCN</b>	<b>Description</b>
1a.	7002798xxx	2" First Edition™ Slat
1b.	7007074000	2" Universal Tape Spacer
2.	5003004xxx	2" Low Profile Headrail
3.	5908035000	2" Low Profile Headrail End Cap
4a.	5003046xxx	2" Low Profile Installation Bracket
4b.	5003158000	2" Low Profile Intermediate Support Bracket
5a.	5003873748	Tilter 2in Cord Gray
5b.	5009075xxx	1.4mm Tilt Cord
6a.	5003768000	2" Low Profile Wand Tilter
6b.	Wood Wand	
	WDA24xxx*	24"
	WDA30xxx*	30"
	WDA36xxx*	36"
	WDA48xxx*	48"
	*Wood wand assembly comprised of:	
	-Wood Wand	
	-Wood Wand Connector Kit (Wand Cap – 7008700000)	
7.	5003680000	Tape Roll 2" EPIC – B
8.	5003572000	Support Tape Roll 2" Unv. Ladders – B
9.	5003367000	2" Low Profile Cordlock EPIC
10.	5003033000	2" Low Profile Tiltrod – Modified Hex
11.	5003074xxx	No Loop Cable Tape Ladder – 44mm
12a.	5009075xxx	1.4 mm Lift Cord
12b.	5008087000	Cord Stop Washer
12c.	7007736xxx	Cylindrical Cord Stop
12d.	2930320xxx	2.2mm Tassel Cord
12e.	5008083000	Lift Cord Grommet
13.	GTxxx	Wood Tassel
14.	7003198xxx	First Edition Bottom Rail
15.	7004034xxx	Wood Tape Button
16.	7005798xxx	3" Standard Valance
17.	7007845000	Universal Valance Clip
18a.	7007541000	Valance Splice
18b.	7007444000	Universal Valance Corner Key
18c.	2980246000	Child Safety Kit (Cord Cleat)

### **Optional Parts:**

19a.	5003167000	2" Low Profile Short Extension Bracket (Short)
19b.	5003168000	2" Low Profile Long Extension Bracket (Long)
19c.	5003142000	Spacer Block (2" Low Profile Bracket 3/8" Thick)
19d.	5003156000	Spacer Block (2" Low Profile Support Bracket 3/8" Thick)
19e.	7007069000	1/8" Bracket Shim
20a.	7007075000	2" Hold-Down Bracket (Sill)
20b.	7007076000	2" Hold-Down Bracket (Jamb)
20c.	5007307000	Hold-Down Pin
21.	5003251000	Clip 2" Omega (Used on multiple blinds)

xxx = 3-digit color code

# 2" First Edition™ Optional Hardware

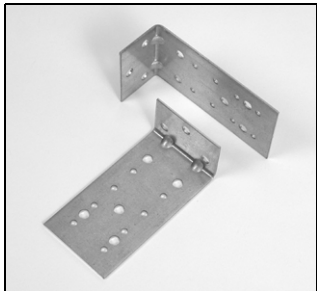

LP Short Extension Bracket  
PCN 5003167000

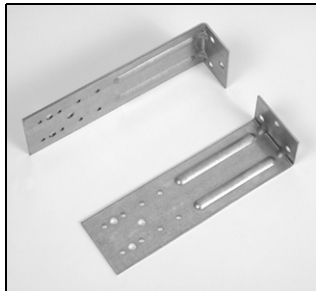

LP Long Extension Bracket  
PCN 5003168000

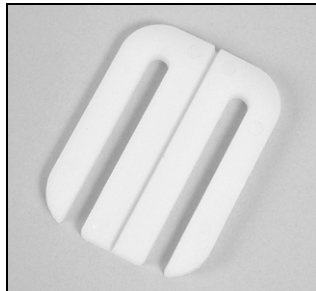

1/8" Bracket Shim  
PCN 7007069000



2" Hold-Down Bracket (Sill)  
PCN 7007075000

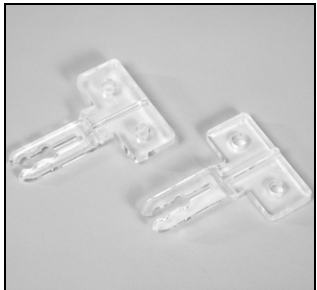

2" Hold-Down Bracket (Jamb)  
PCN 7007076000



Hold-Down Pin  
PCN 5007307000

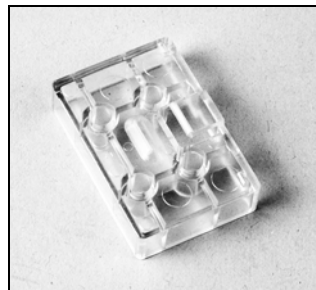

Spacer Block 2" LP Bracket  
PCN 5003142000

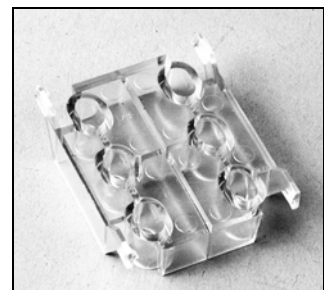

Spacer Block 2" LP Support  
Bracket  
PCN 5003156000